

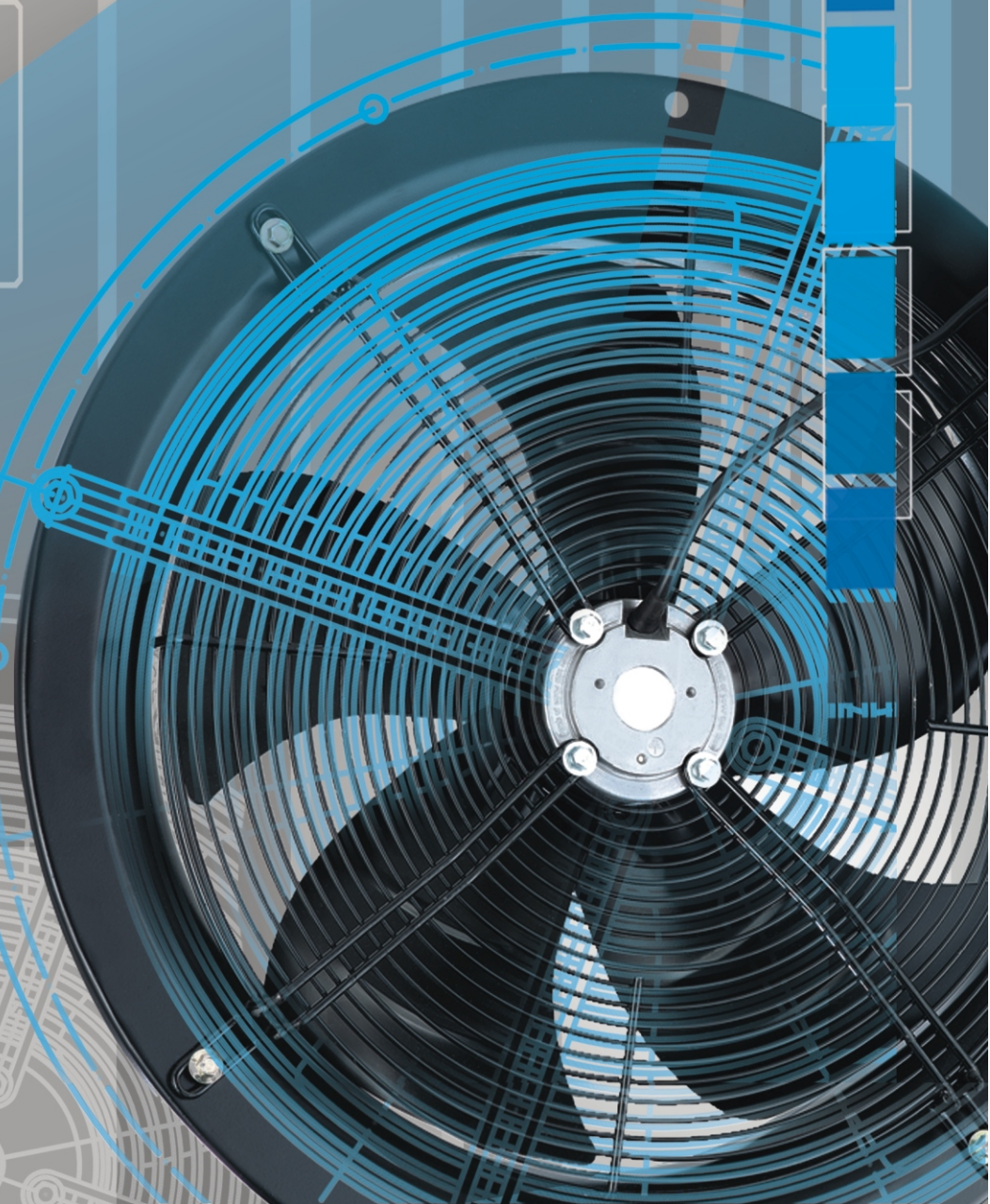

# DOSPEL

Leader in ventilation

## PRODUCT CATALOGUE

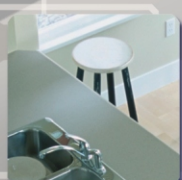
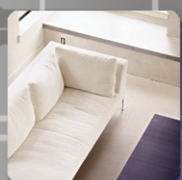

## THE GROUP OF DOMESTIC FANS INCLUDES:



### Wall fans

are used to transfer the air out of a room by a system of ventilation shafts and ducts.



### Ceiling fans

use ball bearings in their motors to ensure their longevity and smooth, quiet running.



### Window fans

allow for the installation of advanced axial fans in windows, through the actual panes of glass. These fans are used as an effective alternative ventilation system.

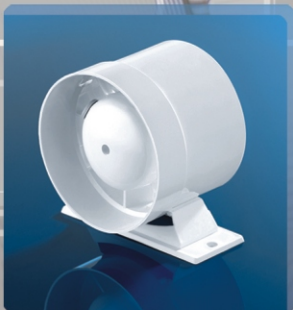

### Duct fans

are used to transfer or increase the air flow inside ventilation ducts.

## DOMESTIC FANS

DOSPEL domestic fans are universal fans. They are widely used for the ventilation of bathrooms, kitchens, toilets, as well as offices, houses, flats. There are four typical sizes of fans produced for ventilation ducts, diameters being 100, 120, 150, 200 mm. Fan casings are made of high quality ABS plastic with an antistatic additive, this prevents dust accumulating on the casing.

Most of the models are manufactured with IP X4 protection class.

In Dospel fans there are motors with ball bearings and slide bearings used. A motor with ball bearings extends the working life of the fan, reduces the noise and can be installed at a desired angle. Fans with slide bearings can only be installed in a vertical position, (either within or on a wall).

### AVAILABLE VERSIONS OF DOSPEL DOMESTIC FANS:

- S** - standard version.
- WP** - pull cord switch\*.
- WC** - adjustable timer that can be set manually for the time of 2 to 23 minutes.
- WCH** - adjustable humidistat - the fan starts and continues to run through an inbuilt timer after the humidity level is reached (from 2 to 23 minutes).
- PIR** - Passive Infra Red - movement sensor - the fan starts after movement is detected in a specified area and continues to work for a time determined by an adjustable timer (from 2 to 23 minutes).
- AŽ** - automatic shutters open after the fan is started, and they close automatically after it is switched off and block further air inlet (the response time is about 40 seconds).
- K** - backdraught shutter which prevents reverse air flow.
- L** - motors with ball bearings are quieter and have an extended working life, these can be installed in any position. It can be installed at an optional angle.

\* available with wire and plug

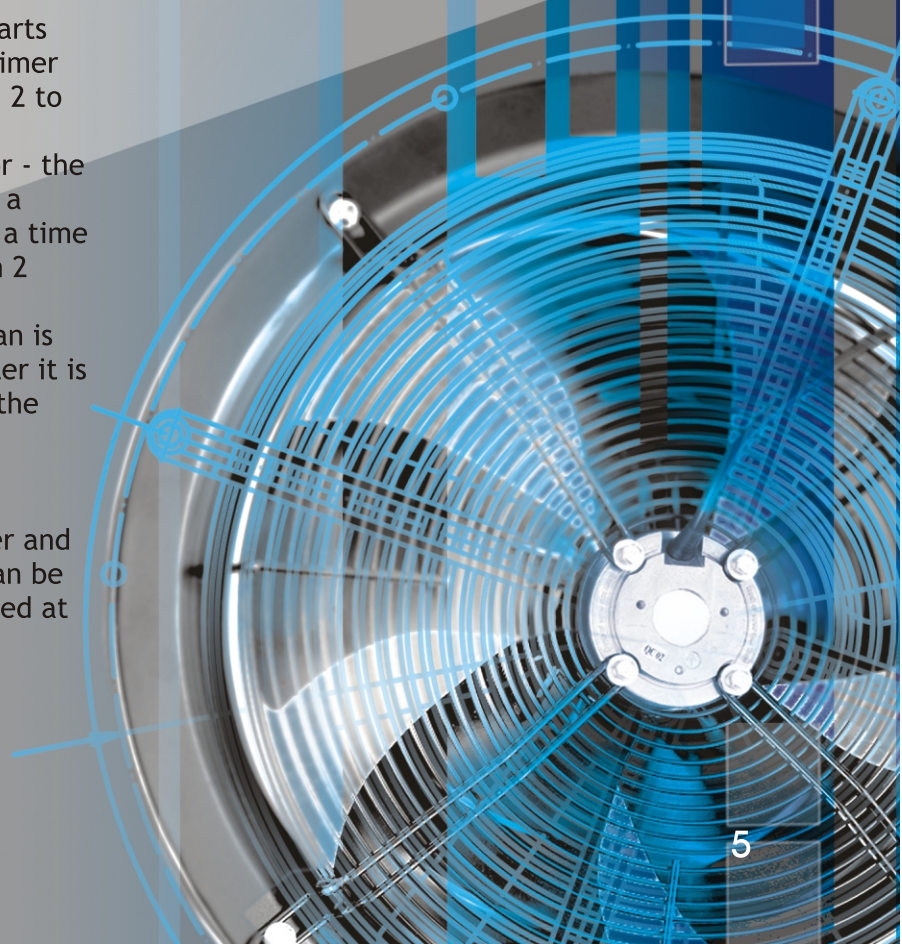

# STYL

STYL Ø100  
STYL Ø120  
STYL Ø150  
STYL Ø200



Axial fans of the STYL line

Typical sizes available:  
Ø100, Ø120, Ø150, Ø200

Possible versions:

S - standard

WP - pull cord switch\*

WC - adjustable timer

Additional functions:

K - backdraught shutter

(only for versions Ø100, Ø120

L - a motor with ball bearings,

only for versions Ø100, Ø120, Ø150

(can be installed in any position)

Available colours:

- white

- graphite (only for a version Ø100)

- golden (only for a version Ø100)

- silver (only for a version Ø100)

Material:

STYL Ø200: ABS,

STYL Ø100, Ø120, Ø150: ABS/PP.

\* available with wire and plug

This is an early product line and has proven to be very popular. STYL fans have a modern design, are user friendly and every model is equipped with a fly screen.

STYL fans Ø200 are available in two versions with a motor of two speeds; they can work in high or low gear, depending on the users requirements (280 or 400 m<sup>3</sup>/h).

## TECHNICAL DRAWING

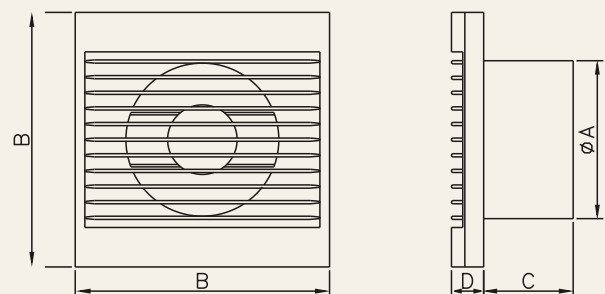

	ØA	B	C	D
STYL Ø100	98	157	56	20
STYL Ø120	118	157	56	20
STYL Ø150	148	200	75	20
STYL Ø200	198	260	80	20

## TECHNICAL DATA

Model	Air flow [m <sup>3</sup> /h]	Static pressure [Pa]	Static pressure [mmH <sub>2</sub> O]	Acoustic pressure [dB(A) 1 m]	Power supply voltage [V/Hz]	Motor speed [rpm]	Power [W]	Power consumption [A]	Max. working temperature [°C]	Weight [kg]	Motor protection rated [IP]	Insulation class
STYL Ø100	100	34	3,47	40	230/50	2650	15	0,10	40	0,50	X4	□
STYL Ø120	150	49	4,99	46	230/50	2650	20	0,11	40	0,60	X4	□
STYL Ø150	280	68	6,93	47	230/50	2650	25	0,15	40	0,70	X4	□
STYL Ø200	HS	400	60	6,12	230/50	2500	35	0,22	40	1,00	X2	□
	LS	280	40	4,08		2100	23	0,15				

HS-high speed  
LS-low speed

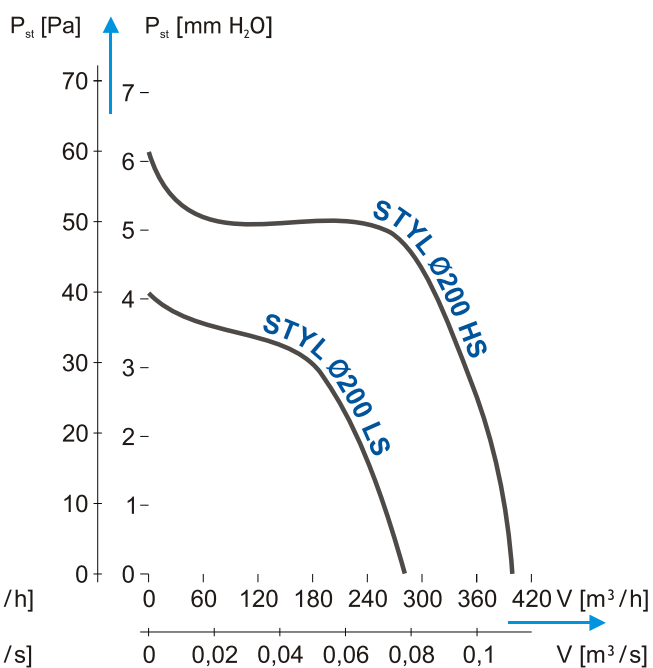
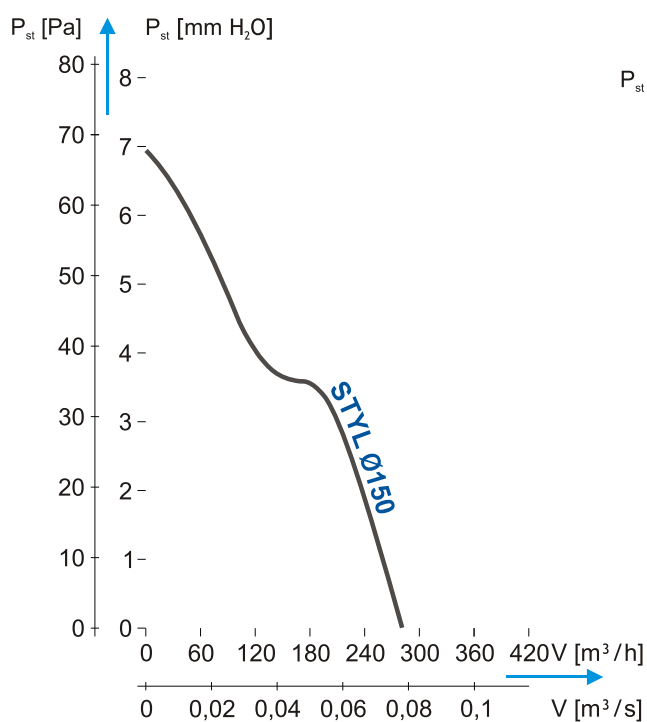
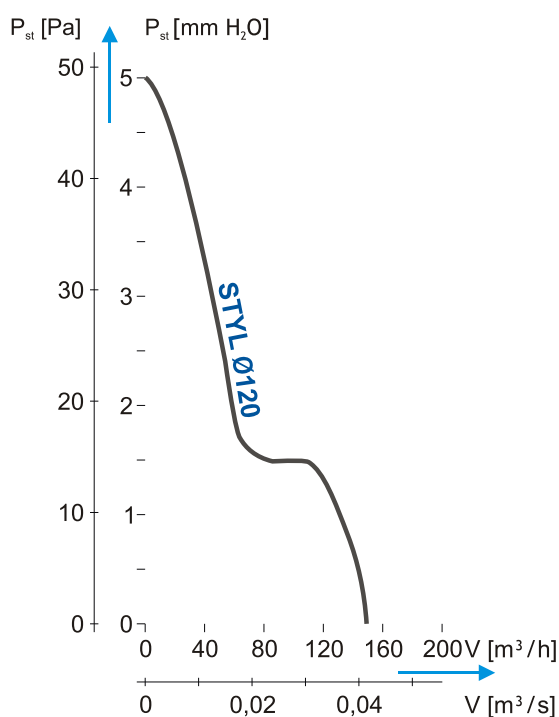
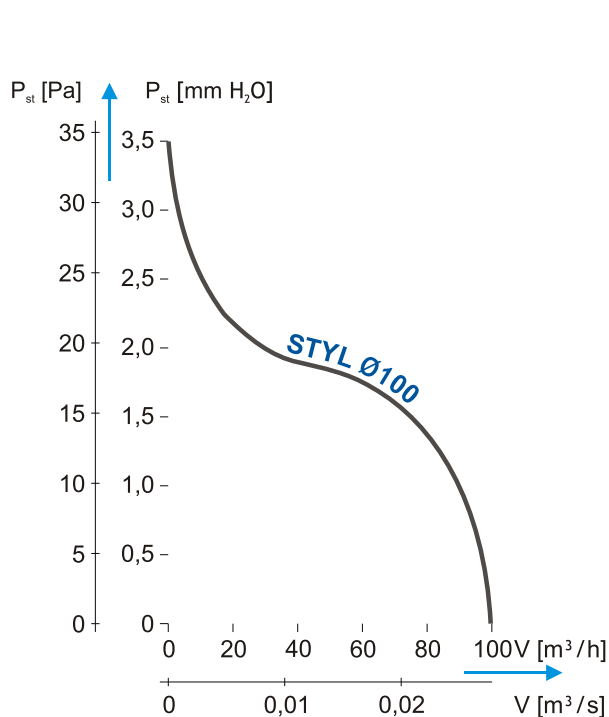

# STYL

STYL Ø100  
 STYL Ø120  
 STYL Ø150  
 STYL Ø200

Model	EAN	Item number	Colour	Bulk packaging
STYL Ø100 S	590 2289 00102	007 - 0001	white	20 pcs.
STYL Ø100 SK	590 2289 00097	007 - 0290	white	20 pcs.
STYL Ø100 SL	590 7466 67343	007 - 1291	white	20 pcs.
STYL Ø100 SKL	590 7466 67344	007 - 1292	white	20 pcs.
STYL Ø100 S	590 2289 00090	007 - 0442	silver	20 pcs.
STYL Ø100 SK	590 2289 00088	007 - 0630	silver	20 pcs.
STYL Ø100 SL	590 7466 67345	007 - 1293	silver	20 pcs.
STYL Ø100 SKL	590 7466 67346	007 - 1294	silver	20 pcs.
STYL Ø100 S	590 2289 00092	007 - 0444	golden	20 pcs.
STYL Ø100 SK	590 2289 00110	007 - 0631	golden	20 pcs.
STYL Ø100 SL	590 7466 67347	007 - 1295	golden	20 pcs.
STYL Ø100 SKL	590 7466 67348	007 - 1296	golden	20 pcs.
STYL Ø100 S	590 2289 00094	007 - 0504	graphite	20 pcs.
STYL Ø100 SK	590 2289 00111	007 - 0610	graphite	20 pcs.
STYL Ø100 SL	590 7466 67349	007 - 1297	graphite	20 pcs.
STYL Ø100 SKL	590 7466 67350	007 - 1298	graphite	20 pcs.
STYL Ø100 WP	590 2289 00108	007 - 0002	white	20 pcs.
STYL Ø100 WPK	590 2289 00099	007 - 0292	white	20 pcs.
STYL Ø100 WPL	590 7466 67351	007 - 1299	white	20 pcs.
STYL Ø100 WPKL	590 7466 67352	007 - 1300	white	20 pcs.
STYL Ø100 WP	590 2289 00091	007 - 0443	silver	20 pcs.
STYL Ø100 WPK	590 7466 67301	007 - 0309	silver	20 pcs.
STYL Ø100 WPL	590 7466 67353	007 - 1301	silver	20 pcs.
STYL Ø100 WPKL	590 7466 67354	007 - 1302	silver	20 pcs.
STYL Ø100 WP	590 2289 00093	007 - 0445	golden	20 pcs.
STYL Ø100 WPK	590 7466 67355	007 - 1303	golden	20 pcs.
STYL Ø100 WPL	590 7466 67356	007 - 1304	golden	20 pcs.

Model	EAN	Item number	Colour	Bulk packaging
STYL Ø100 WPKL	590 7466 67357	007 - 1305	golden	20 pcs.
STYL Ø100 WP	590 2289 00095	007 - 0532	graphite	20 pcs.
STYL Ø100 WPK	590 7466 67358	007 - 1306	graphite	20 pcs.
STYL Ø100 WPL	590 7466 67359	007 - 1307	graphite	20 pcs.
STYL Ø100 WPKL	590 7466 67360	007 - 1308	graphite	20 pcs.
STYL Ø100 WC	590 2289 00103	007 - 0009	white	20 pcs.
STYL Ø100 WCK	590 2289 00089	007 - 0531	white	20 pcs.
STYL Ø100 WCL	590 7466 67361	007 - 1309	white	20 pcs.
STYL Ø100 WCKL	590 7466 67362	007 - 1310	white	20 pcs.
STYL Ø120 S	590 2289 00101	007 - 0003	white	20 pcs.
STYL Ø120 SK	590 2289 00098	007 - 0289	white	20 pcs.
STYL Ø120 SL	590 7466 67363	007 - 1311	white	20 pcs.
STYL Ø120 SKL	590 7466 67364	007 - 1312	white	20 pcs.
STYL Ø120 WP	590 2289 00100	007 - 0004	white	20 pcs.
STYL Ø120 WPK	590 2289 00107	007 - 0285	white	20 pcs.
STYL Ø120 WPL	590 7466 67365	007 - 1313	white	20 pcs.
STYL Ø120 WPKL	590 7466 67366	007 - 1314	white	20 pcs.
STYL Ø120 WC	590 2289 00104	007 - 0010	white	20 pcs.
STYL Ø120 WCK	590 7466 67095	007 - 1049	white	20 pcs.
STYL Ø120 WCL	590 7466 67368	007 - 1316	white	20 pcs.
STYL Ø120 WCKL	590 7466 67369	007 - 1317	white	20 pcs.
STYL Ø150 S	590 2289 00167	007 - 0005	white	20 pcs.
STYL Ø150 SL	590 7466 67370	007 - 1318	white	20 pcs.
STYL Ø150 WP	590 2289 00168	007 - 0006	white	20 pcs.
STYL Ø150 WPL	590 7466 67371	007 - 1319	white	20 pcs.
STYL Ø150 WC	590 2289 00105	007 - 0335	white	20 pcs.
STYL Ø150 WCL	590 7466 67372	007 - 1320	white	20 pcs.
STYL Ø200 S	590 2289 00169	007 - 0007	white	20 pcs.
STYL Ø200 WP	590 2289 00170	007 - 0008	white	20 pcs.
STYL Ø200 WC	590 2289 00106	007 - 0305	white	20 pcs.

## STYL II

STYL II Ø100  
STYL II Ø120  
STYL II Ø150



Axial fans of the STYL II line

**Typical sizes available:**

Ø100, Ø120, Ø150

**Possible versions:**

- S - standard
  - WC - adjustable timer
  - WCH - adjustable humidistat timer
- Additional functions:**
- L - a motor with ball bearings (can be installed in any position)

**Available colours:**

- white

**Material:** ABS

The STYL II fan combines the best values of its predecessor, STYL, i.e. the low noise level, a high efficiency and high quality material. This antistatic additive prevents dust adhesion. These positive attributes have been combined in the subtle design and technical solutions the STYL II range.

### TECHNICAL DRAWING

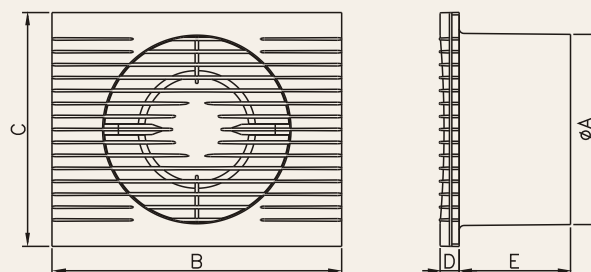

	ØA	B	C	D	E
STYL II Ø100	98	156	124	11	70
STYL II Ø120	118	178	144	12	69
STYL II Ø150	148	216	174	12	76

### TECHNICAL DATA

Model	Air flow [m <sup>3</sup> /h]	Static pressure [Pa]	Static pressure [mmH <sub>2</sub> O]	Acoustic pressure [dB(A) 1 m]	Power supply voltage [V/Hz]	Motor speed [rpm]	Power [W]	Power consumption [A]	Max. working temperature [°C]	Weight [kg]	Motor protection rated [IP]	Insulation class
STYL II Ø100	100	34	3,47	40	230/50	2650	15	0,10	40	0,41	X4	□
STYL II Ø120	150	49	4,99	46	230/50	2650	20	0,11	40	0,52	X4	□
STYL II Ø150	280	68	6,93	47	230/50	2650	25	0,15	40	0,64	X4	□

\* with humidistat X2



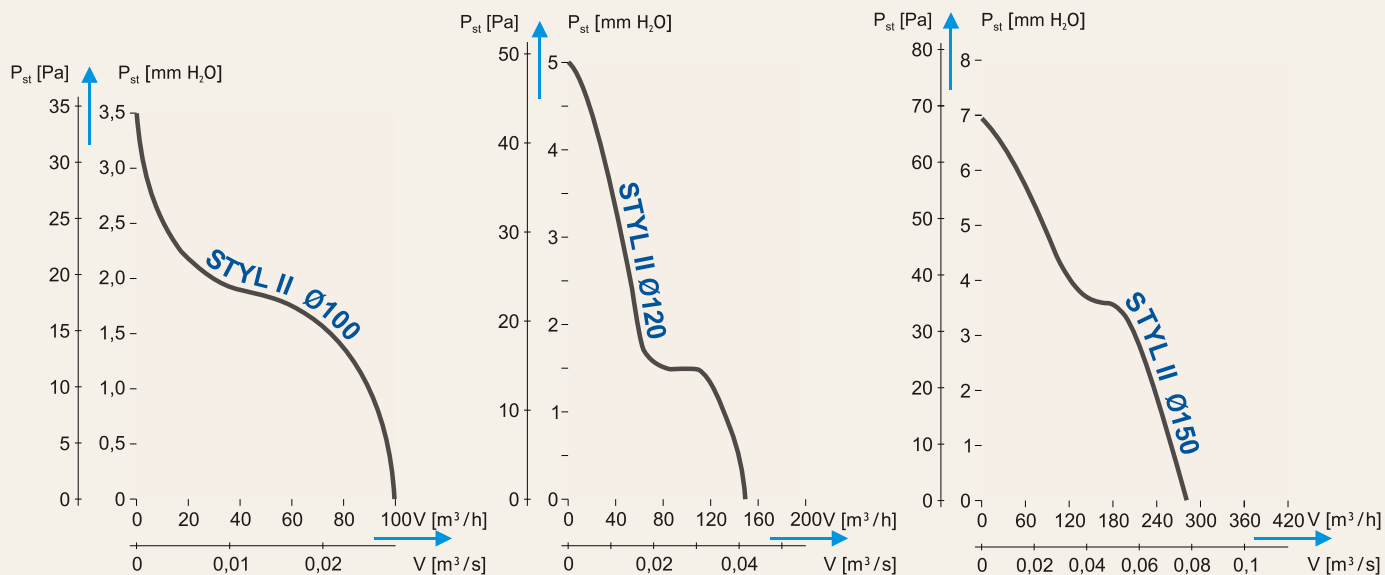

Model	EAN	Item number	Colour	Bulk packaging
STYL II Ø100 S	590 7466 67156	007 - 1128	white	20 pcs.
STYL II Ø100 SL	590 7466 67376	007 - 1324	white	20 pcs.
STYL II Ø100 WC	590 7466 67157	007 - 1129	white	20 pcs.
STYL II Ø100 WCL	590 7466 67377	007 - 1325	white	20 pcs.
STYL II Ø100 WCH	590 7466 67158	007 - 1130	white	20 pcs.
STYL II Ø100 WCHL	590 7466 67378	007 - 1326	white	20 pcs.
STYL II Ø120 S	590 7466 67159	007 - 1131	white	20 pcs.
STYL II Ø120 SL	590 7466 67379	007 - 1327	white	20 pcs.
STYL II Ø120 WC	590 7466 67160	007 - 1132	white	20 pcs.
STYL II Ø120 WCL	590 7466 67380	007 - 1328	white	20 pcs.
STYL II Ø120 WCH	590 7466 67161	007 - 1133	white	20 pcs.
STYL II Ø120 WCHL	590 7466 67381	007 - 1329	white	20 pcs.
STYL II Ø150 S	590 7466 67162	007 - 1134	white	10 pcs.
STYL II Ø150 SL	590 7466 67382	007 - 1330	white	10 pcs.
STYL II Ø150 WC	590 7466 67163	007 - 1135	white	10 pcs.
STYL II Ø150 WCL	590 7466 67383	007 - 1331	white	10 pcs.
STYL II Ø150 WCH	590 7466 67164	007 - 1136	white	10 pcs.
STYL II Ø150 WCHL	590 7466 67384	007 - 1332	white	10 pcs.

# POLO

POLO 4 Ø100  
 POLO 5 Ø120  
 POLO 6 Ø150



Axial fans of the POLO line

**Typical sizes available:**

Ø100, Ø120, Ø150

**Possible versions:**

- S - standard
- WP - pull cord switch\*
- WC - adjustable timer
- WCH - adjustable humidistat timer
- PIR - Passive Infra Red (movement sensor)
- AŽ - automatic shutter

**Additional functions:**

- L - a motor with ball bearings (can be installed in any position)

**Available colours:**

- white

**Material:** ABS.

\* available with wire and plug

Automatic Shutters are available as an option with this product. These close to prevent the reverse air flow into a room when the fan is switched off. With a great choice of additional functions even the most demanding of customers can select the appropriate range of fan for their needs.

## TECHNICAL DRAWING

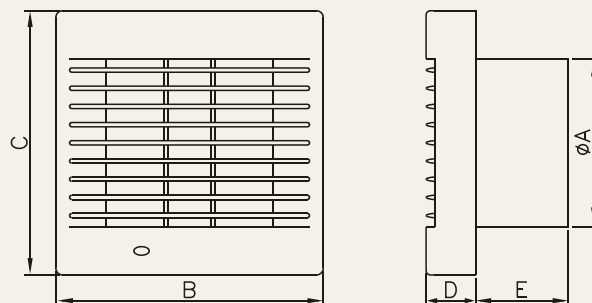

	ØA	B	C	D	E
POLO 4 Ø100	98	156	154	29	55
POLO 5 Ø120	118	179	178	31	59
POLO 6 Ø150	148	209	208	31	69

## TECHNICAL DATA

Model	Air flow [m <sup>3</sup> /h]	Static pressure [Pa]	Static pressure [mmH <sub>2</sub> O]	Acoustic pressure [dB(A) 1 m]	Power supply voltage [V/Hz]	Motor speed [rpm]	Power [W]	Power consumption [A]	Max. working temperature [°C]	Weight [kg]	Motor protection rated [IP]	Insulation class
POLO 4 Ø100	100	34	3,47	40	230/50	2650	15	0,10	40	0,50	X4	□
POLO 5 Ø120	150	49	4,99	46	230/50	2650	20	0,11	40	0,60	X4	□
POLO 6 Ø150	280	68	6,93	47	230/50	2650	25	0,15	40	0,70	X4	□

\* with humidistat X2

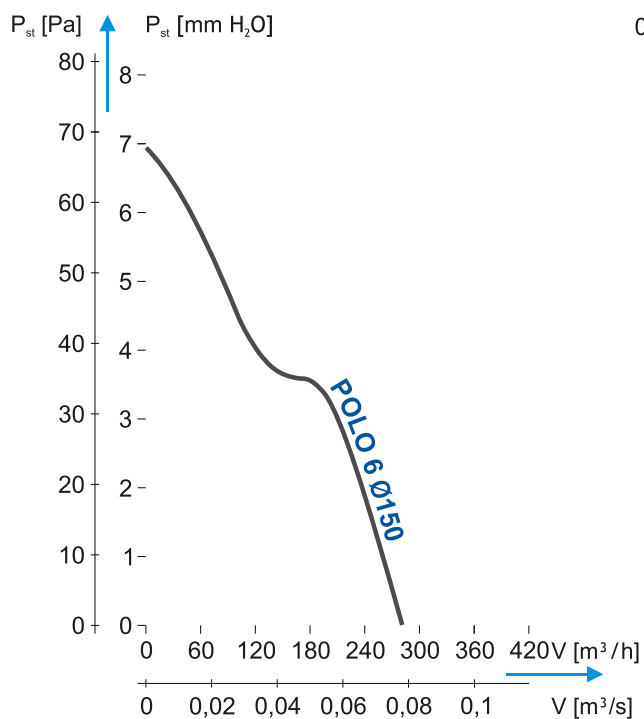
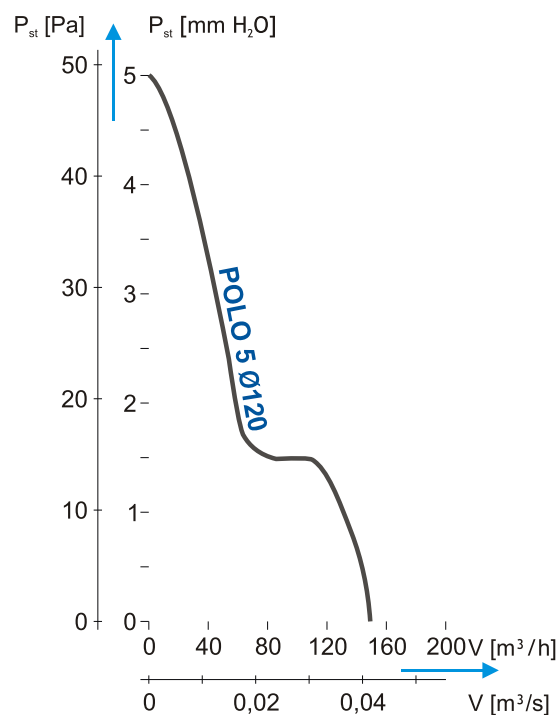
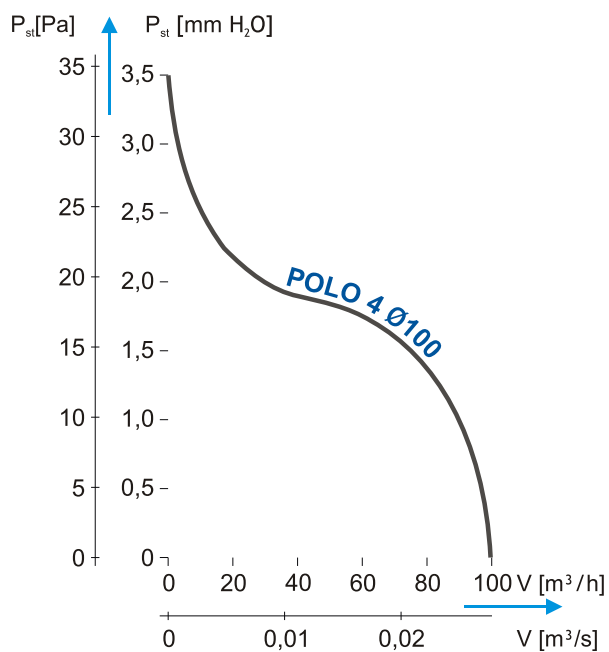

# POLO

POLO 4 Ø100  
POLO 5 Ø120  
POLO 6 Ø150

Model	EAN	Item number	Colour	Bulk packaging
POLO 4 Ø100 S	590 2289 00121	007 - 0054	white	10 pcs.
POLO 4 Ø100 SL	590 7466 67385	007 - 1333	white	10 pcs.
POLO 4 Ø100 WP	590 2289 00123	007 - 0056	white	10 pcs.
POLO 4 Ø100 WPL	590 7466 67386	007 - 1334	white	10 pcs.
POLO 4 Ø100 WC	590 2289 00125	007 - 0058	white	10 pcs.
POLO 4 Ø100 WCL	590 7466 67387	007 - 1335	white	10 pcs.
POLO 4 Ø100 WCWP	590 2289 00127	007 - 0059	white	10 pcs.
POLO 4 Ø100 WCWPL	590 7466 67388	007 - 1336	white	10 pcs.
POLO 4 Ø100 WCH	590 2289 00135	007 - 0061	white	10 pcs.
POLO 4 Ø100 WCHL	590 7466 67389	007 - 1337	white	10 pcs.
POLO 4 Ø100 PIR	590 2289 00085	007 - 0390	white	10 pcs.
POLO 4 Ø100 PIRL	590 7466 67390	007 - 1338	white	10 pcs.
POLO 4 Ø100 AŽ	590 2289 00112	007 - 0055	white	10 pcs.
POLO 4 Ø100 AŽL	590 7466 67391	007 - 1339	white	10 pcs.
POLO 4 Ø100 AŽWP	590 2289 00131	007 - 0057	white	10 pcs.
POLO 4 Ø100 AŽWPL	590 7466 67392	007 - 1340	white	10 pcs.
POLO 4 Ø100 AŽWC	590 2289 00129	007 - 0284	white	10 pcs.
POLO 4 Ø100 AŽWCL	590 7466 67393	007 - 1341	white	10 pcs.
POLO 4 Ø100 AŽWCWP	590 2289 00133	007 - 0060	white	10 pcs.
POLO 4 Ø100 AŽWCWPL	590 7466 67394	007 - 1342	white	10 pcs.
POLO 4 Ø100 AŽWCH	590 2289 00139	007 - 0275	white	10 pcs.
POLO 4 Ø100 AŽWCHL	590 7466 67395	007 - 1343	white	10 pcs.
POLO 4 Ø100 AŽPIR	590 2289 00086	007 - 0391	white	10 pcs.
POLO 4 Ø100 AŽPIRL	590 7466 67396	007 - 1344	white	10 pcs.
POLO 5 Ø120 S	590 2289 00221	007 - 0036	white	10 pcs.
POLO 5 Ø120 SL	590 7466 67397	007 - 1345	white	10 pcs.
POLO 5 Ø120 WP	590 2289 00222	007 - 0168	white	10 pcs.
POLO 5 Ø120 WPL	590 7466 67398	007 - 1346	white	10 pcs.
POLO 5 Ø120 WC	590 2289 00223	007 - 0037	white	10 pcs.
POLO 5 Ø120 WCL	590 7466 67399	007 - 1347	white	10 pcs.
POLO 5 Ø120 WCWP	590 2289 00224	007 - 0167	white	10 pcs.
POLO 5 Ø120 WCWPL	590 7466 67400	007 - 1349	white	10 pcs.
POLO 5 Ø120 WCH	590 2289 00225	007 - 0114	white	10 pcs.
POLO 5 Ø120 WCHL	590 7466 67401	007 - 1350	white	10 pcs.

Model	EAN	Item number	Colour	Bulk packaging
POLO 5 Ø120 PIR	590 2289 00257	007 - 0482	white	10 pcs.
POLO 5 Ø120 PIRL	590 7466 67402	007 - 1351	white	10 pcs.
POLO 5 Ø120 AŽ	590 2289 00229	007 - 0028	white	10 pcs.
POLO 5 Ø120 AŽL	590 7466 67403	007 - 1352	white	10 pcs.
POLO 5 Ø120 AŽWP	590 2289 00230	007 - 0034	white	10 pcs.
POLO 5 Ø120 AŽWPL	590 7466 67404	007 - 1353	white	10 pcs.
POLO 5 Ø120 AŽWC	590 2289 00236	007 - 0030	white	10 pcs.
POLO 5 Ø120 AŽWCL	590 7466 67405	007 - 1354	white	10 pcs.
POLO 5 Ø120 AŽWCWP	590 2289 00231	007 - 0033	white	10 pcs.
POLO 5 Ø120 AŽWCWPL	590 7466 67406	007 - 1355	white	10 pcs.
POLO 5 Ø120 AŽWCH	590 2289 00234	007 - 0032	white	10 pcs.
POLO 5 Ø120 AŽWCHL	590 7466 67407	007 - 1356	white	10 pcs.
POLO 5 Ø120 AŽPIR	590 2289 00082	007 - 0678	white	10 pcs.
POLO 5 Ø120 AŽPIRL	590 7466 67408	007 - 1357	white	10 pcs.
POLO 6 Ø150 S	590 2289 00237	007 - 0241	white	10 pcs.
POLO 6 Ø150 SL	590 7466 67409	007 - 1358	white	10 pcs.
POLO 6 Ø150 WP	590 2289 00238	007 - 0293	white	10 pcs.
POLO 6 Ø150 WPL	590 7466 67410	007 - 1359	white	10 pcs.
POLO 6 Ø150 WC	590 2289 00239	007 - 0242	white	10 pcs.
POLO 6 Ø150 WCL	590 7466 67411	007 - 1360	white	10 pcs.
POLO 6 Ø150 WCWP	590 2289 00240	007 - 0273	white	10 pcs.
POLO 6 Ø150 WCWPL	590 7466 67412	007 - 1361	white	10 pcs.
POLO 6 Ø150 WCH	590 2289 00241	007 - 0270	white	10 pcs.
POLO 6 Ø150 WCHL	590 7466 67413	007 - 1362	white	10 pcs.
POLO 6 Ø150 PIR	590 2289 00077	007 - 0676	white	10 pcs.
POLO 6 Ø150 PIRL	590 7466 67414	007 - 1363	white	10 pcs.
POLO 6 Ø150 AŽ	590 2289 00245	007 - 0204	white	10 pcs.
POLO 6 Ø150 AŽL	590 7466 67415	007 - 1364	white	10 pcs.
POLO 6 Ø150 AŽWP	590 2289 00246	007 - 0232	white	10 pcs.
POLO 6 Ø150 AŽWPL	590 7466 67416	007 - 1365	white	10 pcs.
POLO 6 Ø150 AŽWC	590 2289 00252	007 - 0206	white	10 pcs.
POLO 6 Ø150 AŽWCL	590 7466 67417	007 - 1366	white	10 pcs.
POLO 6 Ø150 AŽWCWP	590 2289 00247	007 - 0231	white	10 pcs.
POLO 6 Ø150 AŽWCWPL	590 7466 67418	007 - 1367	white	10 pcs.
POLO 6 Ø150 AŽWCH	590 2289 00250	007 - 0229	white	10 pcs.
POLO 6 Ø150 AŽWCHL	590 7466 67419	007 - 1368	white	10 pcs.
POLO 6 Ø150 AŽPIR	590 2289 00083	007 - 0677	white	10 pcs.
POLO 6 Ø150 AŽPIRL	590 7466 67420	007 - 1369	white	10 pcs.

# FALA COLOR FALA WATER 12V

FALA COLOR Ø100  
FALA WATER 12V Ø100



FALA COLOR axial fans and FALA WATER 12V line

Typical sizes available:

Ø100

Possible versions:

S - standard

WP - pull cord switch\*

Additional functions (FALA COLOR):

K - backdraught shutter

L - a motor with ball bearings

(can be installed in any position)

Available colours:

- white
- willow green
- peach
- light yellow
- beige

Material: ABS/PP

\* available with wire and plug

FALA COLOR axial fans: universal air extract fans in a wide range of colours, together with a modern wave design.

The FALA WATER range has a 12Volt supply from the mains. This guarantees safety for users in high humidity conditions, and when there is a possibility of water intrusion.

## TECHNICAL DRAWING

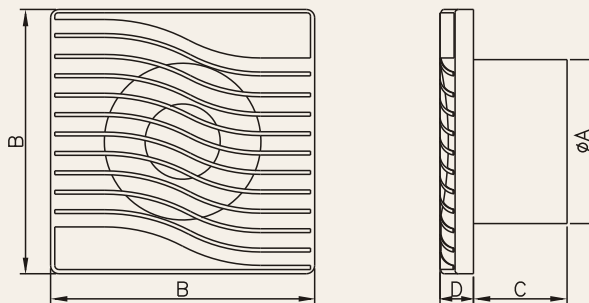

	ØA	B	C	D
FALA COLOR Ø100	98	157	56	20
FALA WATER 12V Ø100				

## TECHNICAL DATA

Model	Air flow [m <sup>3</sup> /h]	Static pressure [Pa]	Static pressure [mmH <sub>2</sub> O]	Acoustic pressure [dB(A) 1 m]	Power supply voltage [V/Hz]	Motor speed [rpm]	Power [W]	Power consumption [A]	Max. working temperature [°C]	Weight [kg]	Motor protection rated [IP]	Insulation class
FALA COLOR Ø100	100	34	3,5	40	230/50	2650	15	0,10	40	0,50	X4	□
FALA WATER 12V Ø100	100	34	3,5	40	~12/50	2650	15	0,10	40	0,50	X4	□

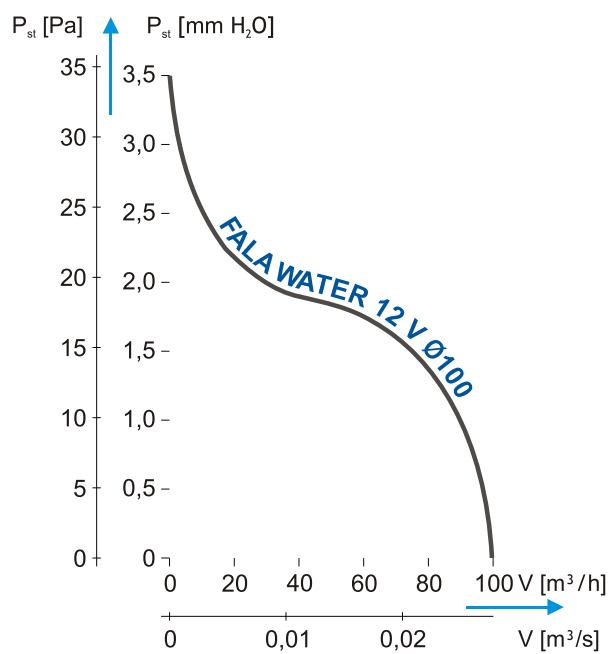
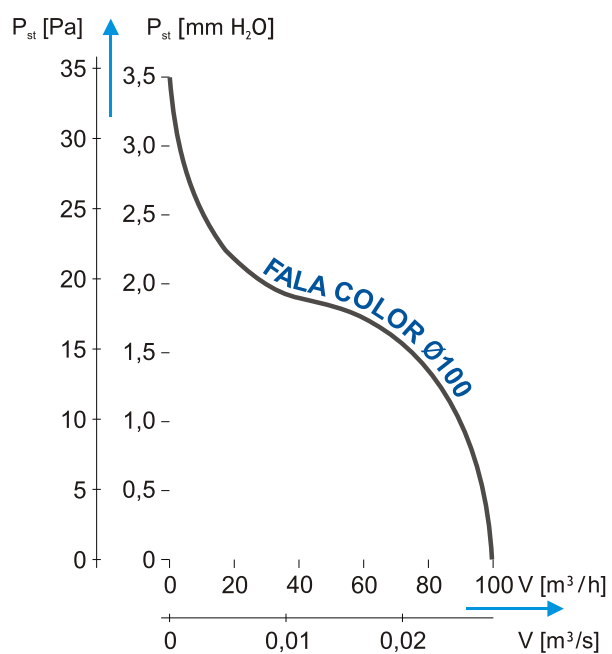

## FALA COLOR

### FALA WATER 12V

FALA COLOR Ø100  
FALA WATER 12V Ø100

Model	EAN	Item number	Colour	Bulk packaging
FALA COLOR Ø100 S	590 2289 00001	007 - 0011	white	20 pcs.
FALA COLOR Ø100 SK	590 2289 00048	007 - 0448	white	20 pcs.
FALA COLOR Ø100 SL	590 7466 67421	007 - 1370	white	20 pcs.
FALA COLOR Ø100 SKL	590 7466 67422	007 - 1380	white	20 pcs.
FALA COLOR Ø100 S	590 2289 00005	007 - 0015	willow green	20 pcs.
FALA COLOR Ø100 SK	590 7466 67423	007 - 1381	willow green	20 pcs.
FALA COLOR Ø100 SL	590 7466 67424	007 - 1382	willow green	20 pcs.
FALA COLOR Ø100 SKL	590 7466 67425	007 - 1383	willow green	20 pcs.
FALA COLOR Ø100 S	590 2289 00012	007 - 0017	peach	20 pcs.
FALA COLOR Ø100 SK	590 7466 67426	007 - 1384	peach	20 pcs.
FALA COLOR Ø100 SL	590 7466 67427	007 - 1385	peach	20 pcs.
FALA COLOR Ø100 SKL	590 7466 67428	007 - 1386	peach	20 pcs.
FALA COLOR Ø100 S	590 2289 00035	007 - 0039	light yellow	20 pcs.
FALA COLOR Ø100 SK	590 7466 67429	007 - 1387	light yellow	20 pcs.
FALA COLOR Ø100 SL	590 7466 67430	007 - 1388	light yellow	20 pcs.
FALA COLOR Ø100 SKL	590 7466 67431	007 - 1389	light yellow	20 pcs.
FALA COLOR Ø100 S	590 2289 00033	007 - 0043	beige	20 pcs.
FALA COLOR Ø100 SK	590 7466 67432	007 - 1390	beige	20 pcs.
FALA COLOR Ø100 SL	590 7466 67433	007 - 1391	beige	20 pcs.
FALA COLOR Ø100 SKL	590 7466 67434	007 - 1392	beige	20 pcs.
FALA COLOR Ø100 WP	590 2289 00002	007 - 0012	white	20 pcs.
FALA COLOR Ø100 WPK	590 2289 00047	007 - 0584	white	20 pcs.
FALA COLOR Ø100 WPL	590 7466 67447	007 - 1405	white	20 pcs.
FALA COLOR Ø100 WPLK	590 7466 67448	007 - 1406	white	20 pcs.



Model	EAN	Item number	Colour	Bulk packaging
FALA COLOR Ø100 WP	590 2289 00006	007 - 0016	willow green	20 pcs.
FALA COLOR Ø100 WPK	590 7466 67449	007 - 1407	willow green	20 pcs.
FALA COLOR Ø100 WPL	590 7466 67450	007 - 1408	willow green	20 pcs.
FALA COLOR Ø100 WPKL	590 7466 67451	007 - 1409	willow green	20 pcs.
FALA COLOR Ø100 WP	590 2289 00013	007 - 0018	peach	20 pcs.
FALA COLOR Ø100 WPK	590 7466 67452	007 - 1410	peach	20 pcs.
FALACOLOR Ø100 WPL	590 7466 67453	007 - 1411	peach	20 pcs.
FALA COLOR Ø100 WPKL	590 7466 67454	007 - 1412	peach	20 pcs.
FALA COLOR Ø100 WP	590 2289 00036	007 - 0040	light yellow	20 pcs.
FALA COLOR Ø100 WPK	590 7466 67455	007 - 1413	light yellow	20 pcs.
FALA COLOR Ø100 WPL	590 7466 67456	007 - 1414	light yellow	20 pcs.
FALA COLOR Ø100 WPKL	590 7466 67457	007 - 1415	light yellow	20 pcs.
FALA WATER 12V Ø100 S	590 2289 00007	007 - 0022	white	20 pcs.
FALA WATER 12V Ø100 S	590 2289 00025	007 - 0020	willow green	20 pcs.
FALA WATER 12V Ø100 S	590 2289 00024	007 - 0021	peach	20 pcs.
FALA WATER 12V Ø100 S	590 2289 00030	007 - 0024	light yellow	20 pcs.
FALA WATER 12V Ø100 S	590 2289 00027	007 - 0026	beige	20 pcs.

# XP COLOR

XP COLOR Ø100



Axial fans of the XP COLOR line

Typical sizes available:

Ø100

Possible versions:

S - standard

WP - pull cord switch\*

WC - adjustable timer

Additional functions:

L - a motor with ball bearings  
(can be installed in any position)

Available colours:

- spring sun
- apricot dream
- sand of desert
- light nephrite

Material: ABS/PP

\* available with wire and plug

The range comes in four different colours, so they can compliment the decor in a given room.

All the versions of the XP COLOR fans are equipped with a flyscreen.

## TECHNICAL DRAWING

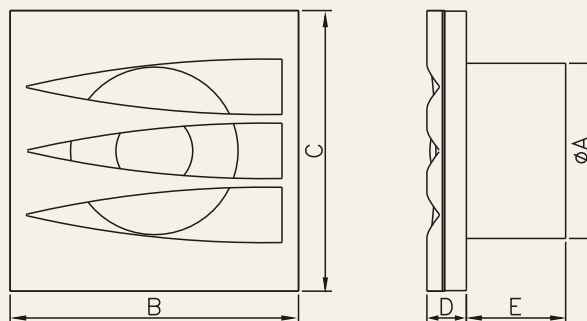

	ØA	B	C	D	E
XP COLOR Ø100	98	162	157	22	56
XP SILVER Ø100					

## TECHNICAL DATA

Model	Air flow [m <sup>3</sup> /h]	Static pressure [Pa]	Static pressure [mmH <sub>2</sub> O]	Acoustic pressure [dB(A) 1 m]	Power supply voltage [V/Hz]	Motor speed [rpm]	Power [W]	Power consumption [A]	Max. working temperature [°C]	Weight [kg]	Motor protection rated [IP]	Insulation class
XP COLOR Ø100 XP SILVER Ø100	100	34	3,47	40	230/50	2650	15	0,10	40	0,50	X4	□



## XP SILVER

XP SILVER Ø100

Axial fans of the XP SILVER line

**Typical sizes available:**

Ø100

**Possible versions:**

- S - standard
- WP - pull cord switch\*
- WC - adjustable timer

**Additional functions:**

- L - a motor with ball bearings (can be installed in any position)

**Available colours:**

- moon night
- misty morning

**Material:** ABS/PP

\* available with wire and plug

The XP SILVER line comes with three different shades of covers.

All the sets of the XP SILVER line are equipped with a flyscreen.

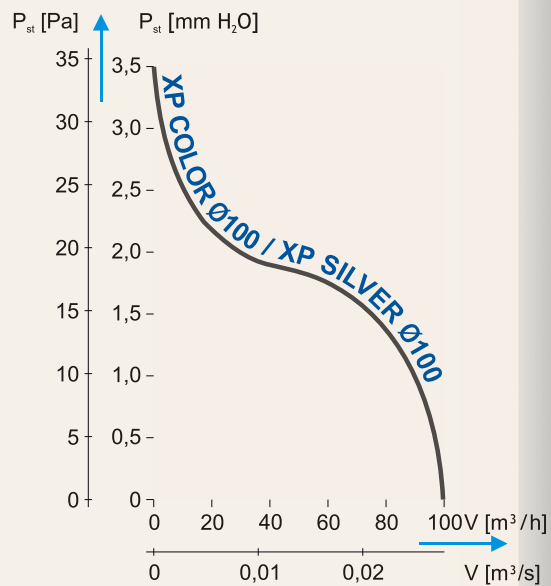

Model	EAN	Item number	Bulk packaging
XP COLOR Ø100 S	590 7466 67565	007 - 1432	10 pcs.
XP COLOR Ø100 WP	590 7466 67567	007 - 1436	10 pcs.
XP COLOR Ø100 WC	590 7466 67568	007 - 1437	10 pcs.
XP COLOR Ø100 SL	590 7466 67618	007 - 1438	10 pcs.
XP COLOR Ø100 WPL	590 7466 67619	007 - 1439	10 pcs.
XP COLOR Ø100 WCL	590 7466 67620	007 - 1440	10 pcs.
XP SILVER Ø100 S	590 7466 67569	007 - 1433	10 pcs.
XP SILVER Ø100 WP	590 7466 67570	007 - 1434	10 pcs.
XP SILVER Ø100 WC	590 7466 67571	007 - 1435	10 pcs.
XP SILVER Ø100 SL	590 7466 67621	007 - 1441	10 pcs.
XP SILVER Ø100 WPL	590 7466 67622	007 - 1442	10 pcs.
XP SILVER Ø100 WCL	590 7466 67623	007 - 1443	10 pcs.

## FRESH DOSPEL

FRESH DOSPEL Ø100  
FRESH DOSPEL Ø120



FRESH DOSPEL axial fans

### TECHNICAL DRAWING

Typical sizes available:

Ø100, Ø120

Possible versions:

S - standard

WC - adjustable timer

WCH - adjustable humidistat timer

Available colours:

- white

- brushed aluminium

Material: ABS, brushed aluminium

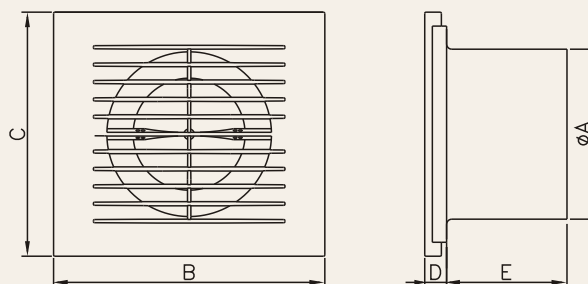

Is a recent addition to the range.  
Available as standard, with a timer,  
and with a humidistat timer.

	ØA	B	C	D	E
FRESH DOSPEL Ø100	98	156	140	12	70
FRESH DOSPEL Ø120	118	189	170	13	69

### TECHNICAL DATA

Model	Air flow [m <sup>3</sup> /h]	Static pressure [Pa]	Static pressure [mmH <sub>2</sub> O]	Acoustic pressure [dB(A) 1 m]	Power supply voltage [V/Hz]	Motor speed [rpm]	Power [W]	Power consumption [A]	Max. working temperature [°C]	Weight [kg]	Motor protection rated [IP]	Insulation class
FRESH DOSPEL Ø100	100	34	3,47	40	230/50	2650	15	0,10	40	0,50	X4	□
FRESH DOSPEL Ø120	150	49	4,99	46	230/50	2650	20	0,11	40	0,60	X4	□

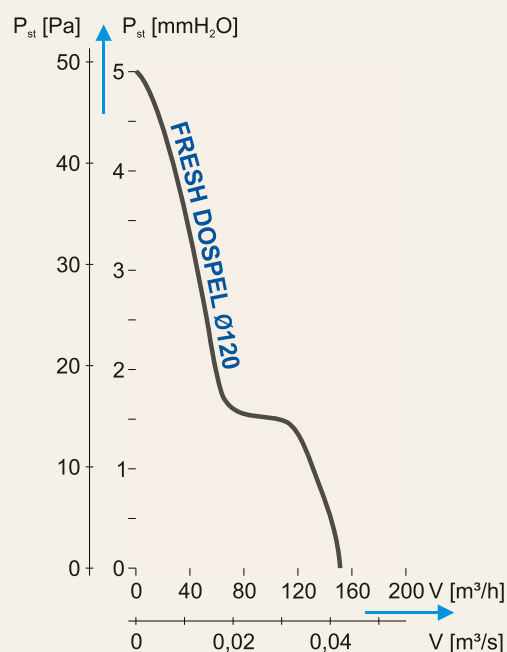
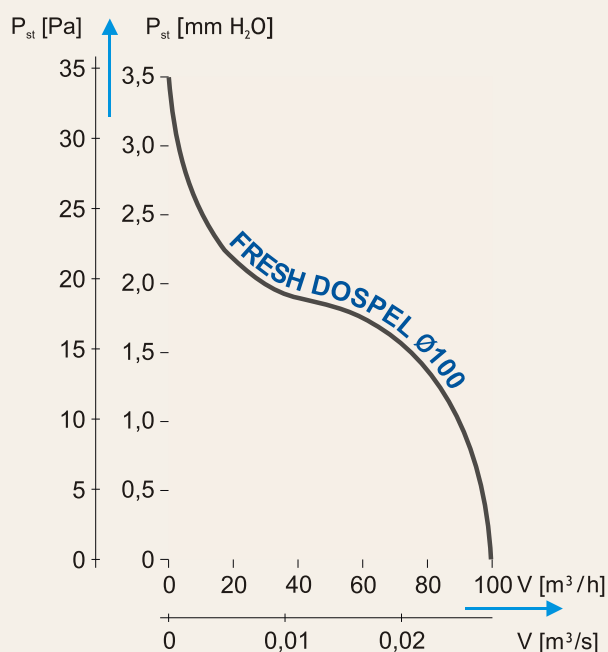

Model	EAN	Item number	Colour	Bulk packaging
FRESH DOSPEL Ø100 S	590 7466 67058	007 - 0996	white	10 pcs.
FRESH DOSPEL Ø100 WC	590 7466 67057	007 - 0997	white	10 pcs.
FRESH DOSPEL Ø100 WCH	590 7466 67954	007 - 1456	white	10 pcs.
FRESH DOSPEL Ø100 S	590 6713 40573	007 - 1501	brushed aluminium	10 pcs.
FRESH DOSPEL Ø100 WC	590 6713 40574	007 - 1502	brushed aluminium	10 pcs.
FRESH DOSPEL Ø100 WCH	590 6713 40575	007 - 1503	brushed aluminium	10 pcs.
FRESH DOSPEL Ø120 S	590 6713 49995	007 - 1483	white	10 pcs.
FRESH DOSPEL Ø120 WC	590 6713 49994	007 - 1482	white	10 pcs.
FRESH DOSPEL Ø120 WCH	590 6713 49996	007 - 1484	white	10 pcs.
FRESH DOSPEL Ø120 S	590 6713 40576	007 - 1504	brushed aluminium	10 pcs.
FRESH DOSPEL Ø120 WC	590 6713 40577	007 - 1505	brushed aluminium	10 pcs.
FRESH DOSPEL Ø120 WCH	590 6713 40578	007 - 1506	brushed aluminium	10 pcs.

# NV

NV 10 Ø100  
 NV 12 Ø120  
 NV 15 Ø150



NV axial fans

- Typical sizes available:  
 Ø100, Ø120, Ø150
- Possible versions:  
 S - standard
- Available colours:  
 - white
- Material: ABS

The standard NV fan has a ball bearing motor, which reduces noise, extends its working life, and enables the installation of the fan vertically and horizontally.

## TECHNICAL DRAWING

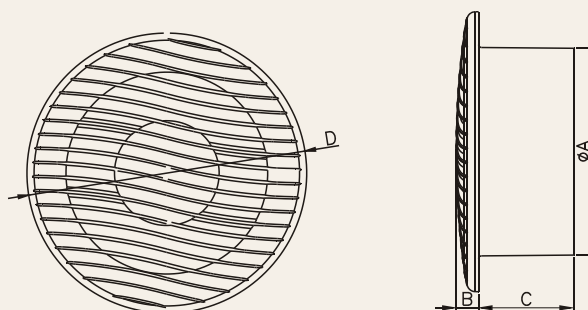

	ØA	B	C	D
NV 10 Ø100	99	15,5	57	132
NV 12 Ø120	119	15,5	58	156
NV 15 Ø150	149	16	69	200

## TECHNICAL DATA

Model	Air flow [m <sup>3</sup> /h]	Static pressure [Pa]	Static pressure [mmH <sub>2</sub> O]	Acoustic pressure [dB(A) 1 m]	Power supply voltage [V/Hz]	Motor speed [rpm]	Power [W]	Power consumption [A]	Max. working temperature [°C]	Weight [kg]	Motor protection rated [IP]	Insulation class
NV 10 Ø100	100	34	3,47	40	230/50	2650	15	0,10	40	0,50	X4	□
NV 12 Ø120	150	49	4,99	46	230/50	2650	20	0,11	40	0,60	X4	□
NV 15 Ø150	280	68	6,93	47	230/50	2650	25	0,15	40	0,70	X4	□

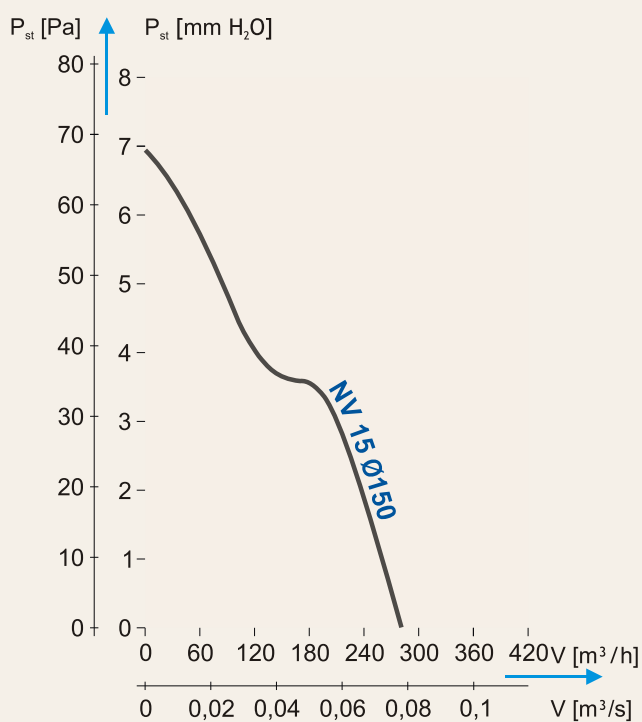
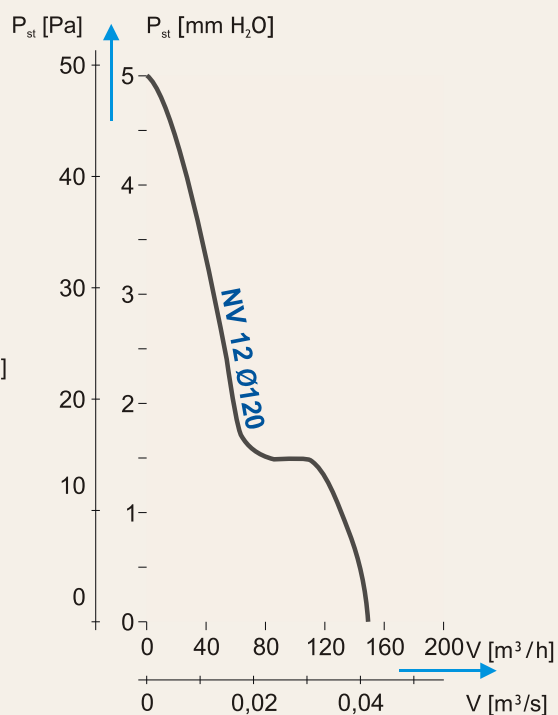
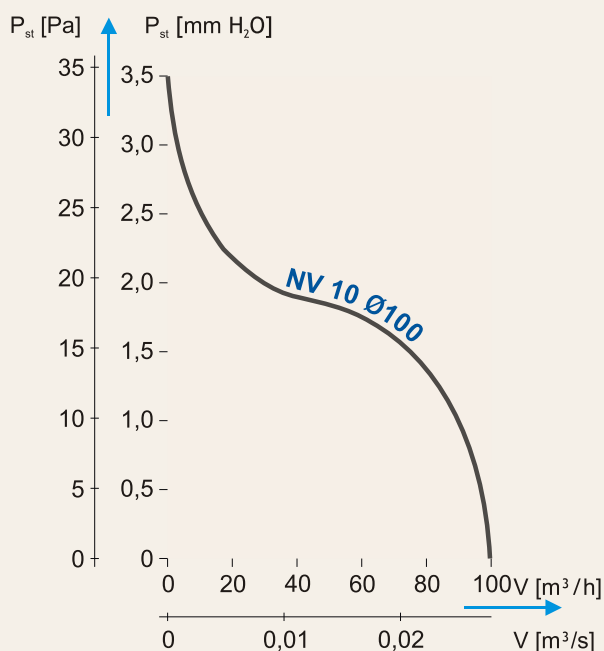

Model	EAN	Item number	Colour	Bulk packaging
NV 10 Ø100	590 2289 00114	007 - 0438	white	10 pcs.
NV 12 Ø120	590 2289 00115	007 - 0439	white	10 pcs.
NV 15 Ø150	590 2289 00116	007 - 0334	white	10 pcs.

# POLO 6 OK

POLO 6 OK Ø150



Axial fans of the POLO 6 OK line

Typical sizes available:  
Ø150

Possible versions:

S - standard

WP - pull cord switch\*

WC - adjustable timer

AZ - automatic shutters

Available colours:

- white

Material: ABS

\* available with wire and plug

These are for installation in windows and are an alternative to extraction through walls.

They are equipped with gravitational shutters that prevent reverse air flow and odours.

## TECHNICAL DRAWING

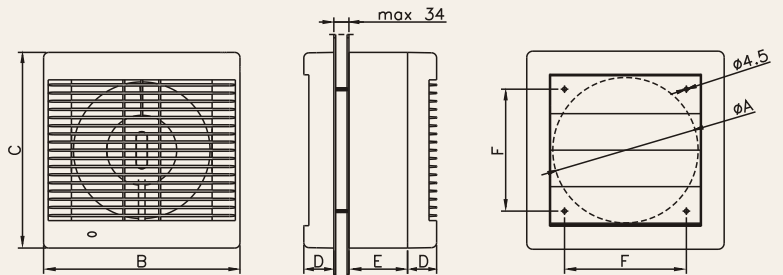

	ØA	B	C	D	E	F
POLO 6 OK Ø150	154	209	208	31	62	130

## TECHNICAL DATA

Model	Air flow [m³/h]	Static pressure [Pa]	Static pressure [mmH₂O]	Acoustic pressure [dB(A) 1 m]	Power supply voltage [V/Hz]	Motor speed [rpm]	Power [W]	Power consumption [A]	Max. working temperature [°C]	Weight [kg]	Motor protection rated [IP]	Insulation class
POLO 6 OK Ø150	200	50	5,10	47	230/50	2650	25	0,13	40	1,20	X4	□



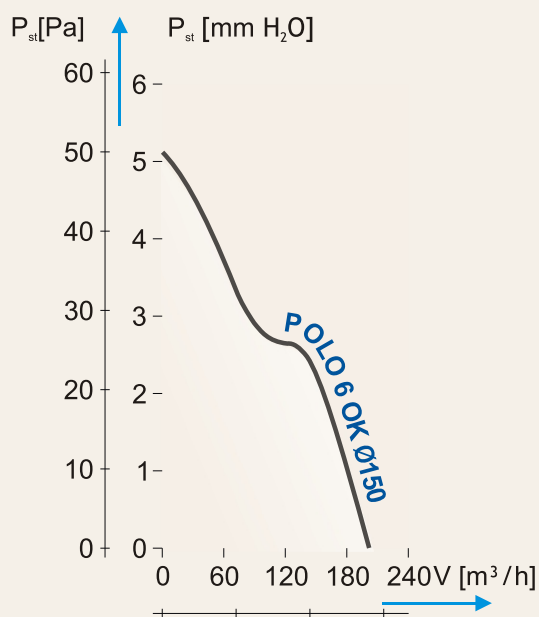
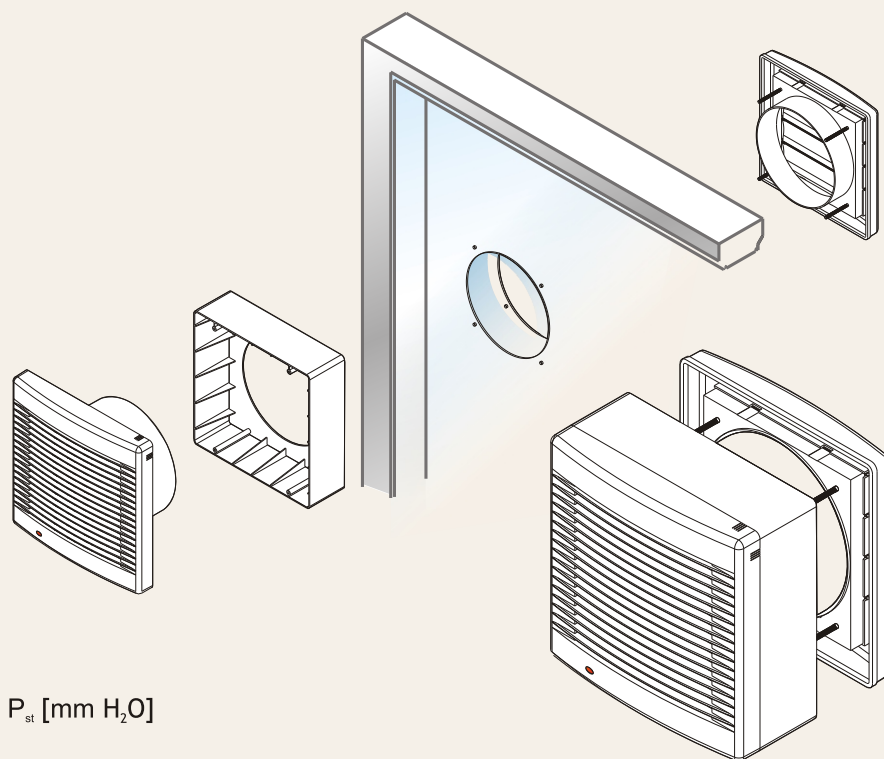

Model	EAN	Item number	Colour	Bulk packaging
POLO 6 OK Ø150 S	590 2289 00253	007 - 0313	white	10 pcs.
POLO 6 OK Ø150 WP	590 2289 00254	007 - 0315	white	10 pcs.
POLO 6 OK Ø150 AŽ	590 7466 67633	007 - 1447	white	10 pcs.
POLO 6 OK Ø150 AŽWP	590 7466 67634	007 - 1448	white	10 pcs.
POLO 6 OK Ø150 AŽWC	590 7466 67635	007 - 1449	white	10 pcs.
POLO 6 OK Ø150 AŽWPWC	590 7466 67636	007 - 1450	white	10 pcs.

# POLO 1 POLO 2

POLO 1 Ø100/104 N  
POLO 1 Ø100/104 W  
POLO 2 Ø125/129 W

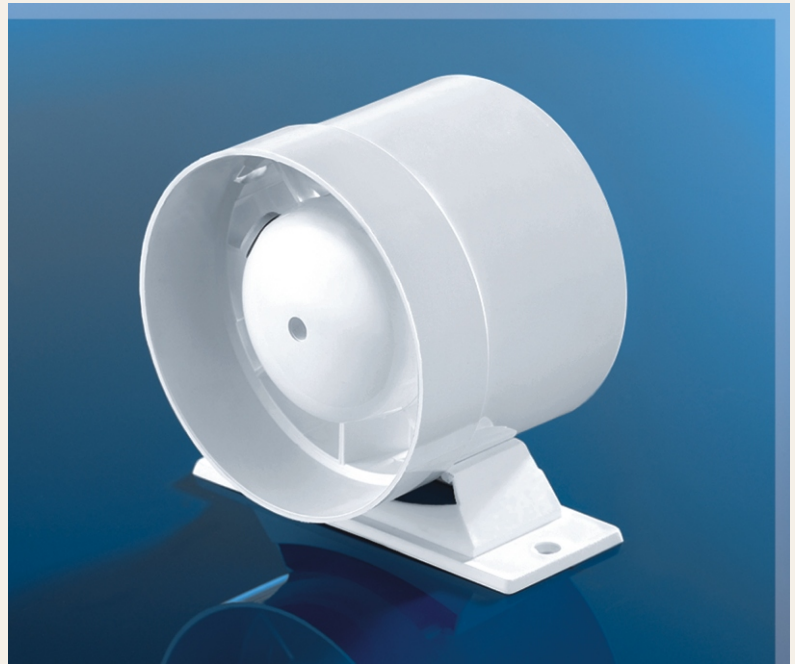

POLO axial fans

Typical sizes available:  
Ø100/104, Ø125/129

Possible versions:

N - air intake

W - air exhaust

Available colours:

- white

Material: ABS

The POLO 1 and POLO 2 are designed to move low to medium air flows short distances. They are installed outside the duct and have fastening points to fix the fan and the adjoining ductwork by screws.

The POLO fan is connected to circular ventilation ducts, with dimensions either side of the POLO fan at 104 and 100mm, or 125 and 129mm to enable connectivity with the duct system.

The dimensions of the POLO duct fans (Ø100/104 and Ø125/129) enable connectivity with ventilation grills, ducting and flex's as integral parts of ducting systems.

## TECHNICAL DRAWING

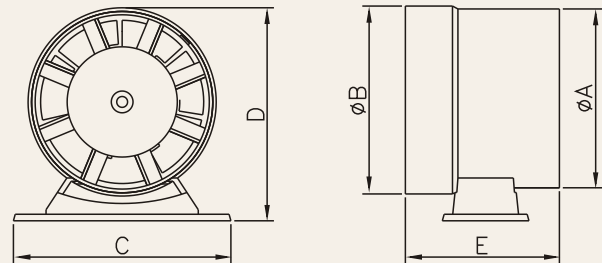

	ØA	ØB	C	D	E
POLO 1 Ø100/104 N	98	104	120	118	84
POLO 1 Ø100/104 W					
POLO 2 Ø125/129 W	125	132	120	148	85

## TECHNICAL DATA

Model	Air flow [m <sup>3</sup> /h]	Static pressure [Pa]	Static pressure [mmH <sub>2</sub> O]	Acoustic pressure [dB(A) 1 m]	Power supply voltage [V/Hz]	Motor speed [rpm]	Power [W]	Power consumption [A]	Max. working temperature [°C]	Weight [kg]	Motor protection rated [IP]	Insulation class
POLO 1 Ø100/104 N POLO 1 Ø100/104 W	100	34	3,47	40	230/50	2650	15	0,10	40	0,50	X2	□
POLO 2 Ø125/129 W	140	40	4,66	46	230/50	2650	20	0,11	40	0,50	X2	□

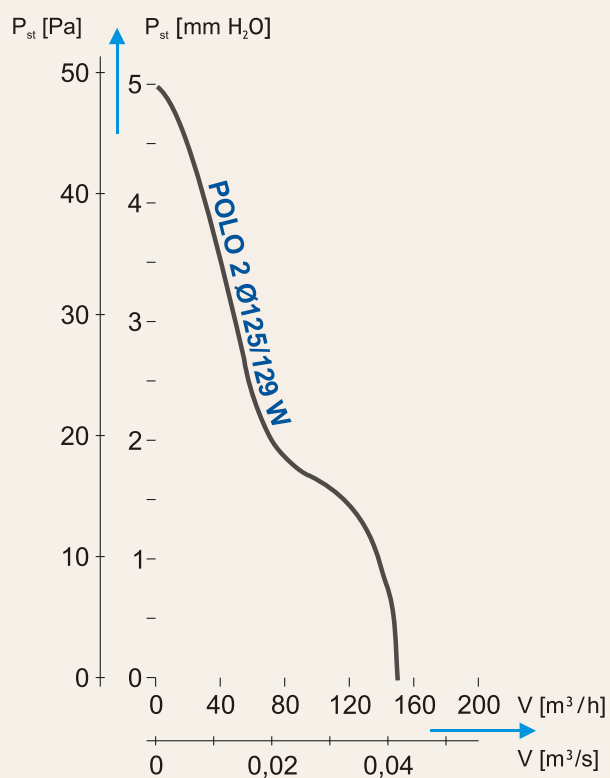
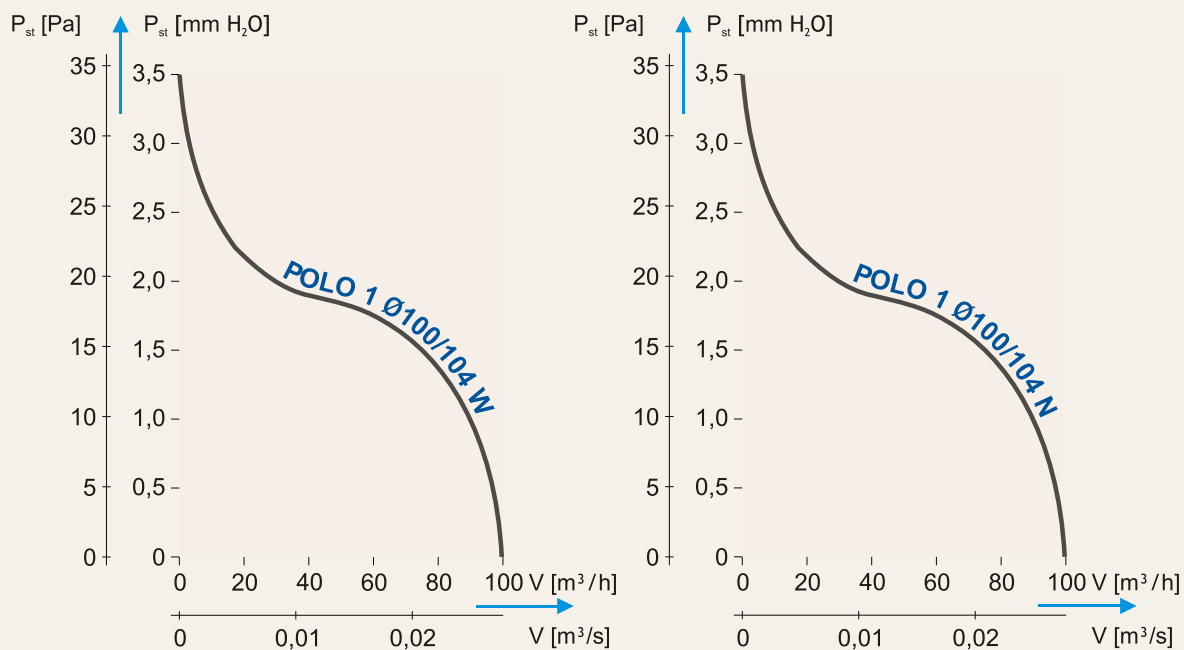

Model	EAN	Item number	Colour	Bulk packaging
POLO 1 Ø100/104 N	590 2289 00197	007 - 0023	white	10 pcs.
POLO 1 Ø100/104 W	590 2289 00175	007 - 0410	white	10 pcs.
POLO 2 Ø125/129 W	590 6713 40609	007 - 1510	white	10 pcs.

## EURO

EURO 1 Ø100  
EURO 2 Ø120  
EURO 3 Ø150

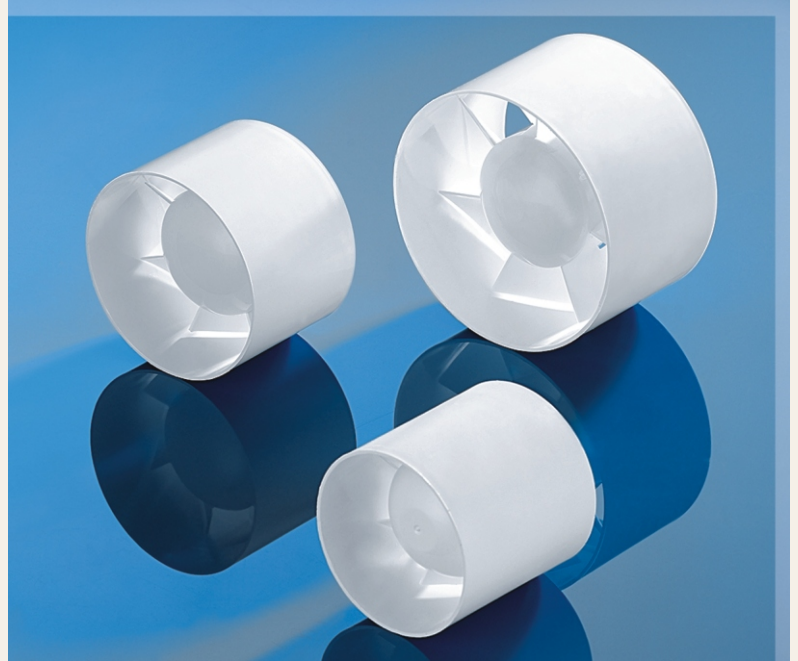

EURO axial fans

### TECHNICAL DRAWING

Typical sizes available:  
Ø100, Ø120, Ø150  
L – a motor with ball bearings  
(can be installed in any position)  
Available colours:  
- white  
Material: ABS

EURO axial fans are designed to move air within ducts and is fitted within the circular ducts.

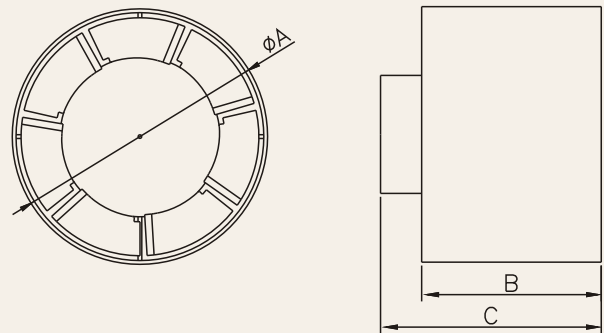

	ØA	B	C
EURO 1 Ø100	99	98	98
EURO 2 Ø120	118	83	102
EURO 3 Ø150	148	92,5	111

### TECHNICAL DATA

Model	Air flow [m <sup>3</sup> /h]	Static pressure [Pa]	Static pressure [mmH <sub>2</sub> O]	Acoustic pressure [dB(A) 1 m]	Power supply voltage [V/Hz]	Motor speed [rpm]	Power [W]	Power consumption [A]	Max. working temperature [°C]	Weight [kg]	Motor protection rated [IP]	Insulation class
EURO 1 Ø100	100	34	3,47	40	230/50	2650	15	0,10	40	0,45	X2	□
EURO 2 Ø120	150	49	4,99	46	230/50	2650	20	0,11	40	0,50	X2	□
EURO 3 Ø150	280	68	6,93	47	230/50	2650	25	0,15	40	0,55	X2	□

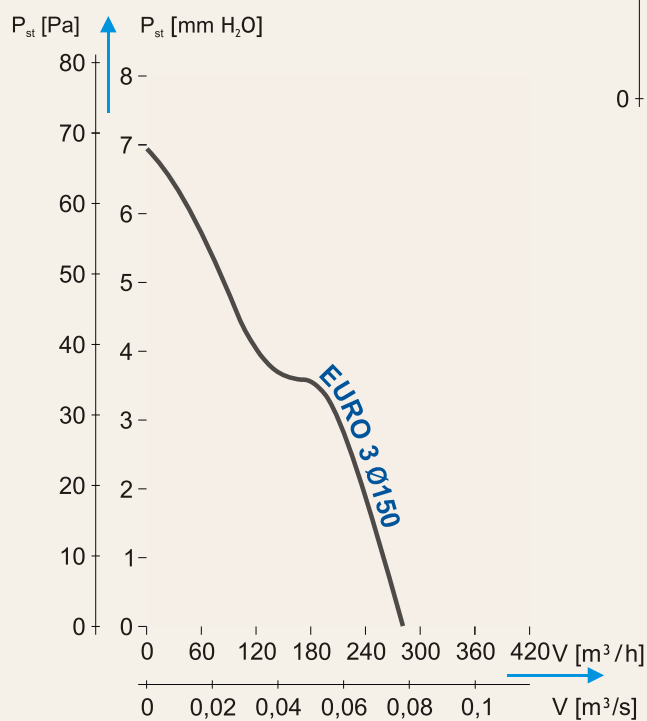
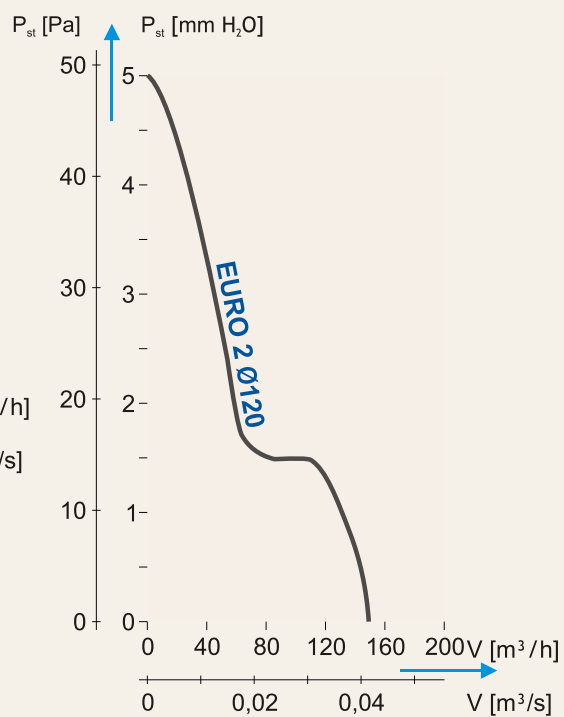
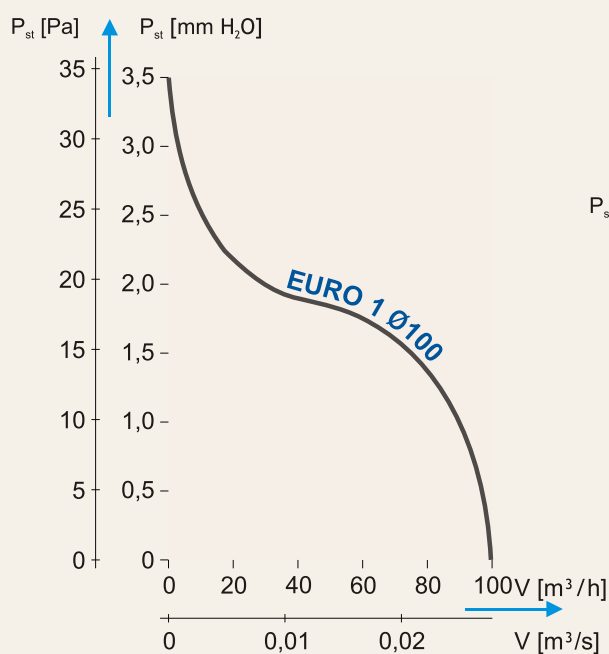

Model	EAN	Item number	Colour	Bulk packaging
EURO 1 Ø100	590 2289 00118	007 - 0051	white	10 pcs.
EURO 2 Ø120	590 2289 00119	007 - 0052	white	10 pcs.
EURO 3 Ø150	590 2289 00120	007 - 0053	white	10 pcs.

# TURBO

TURBO Ø100  
TURBO Ø125



TURBO duct fans

Typical sizes available:  
Ø100, Ø125  
Available colours:  
- white  
Material: ABS

TURBO duct fans are available in versions with a two-speed motor; they can work in high or low gear, depending on what efficiency is required. The advantages of TURBO fans include a low noise level, high efficiency and small dimensions.

## TECHNICAL DRAWING

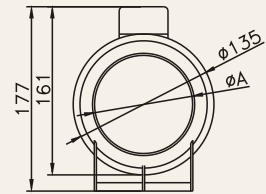
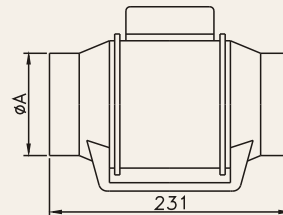
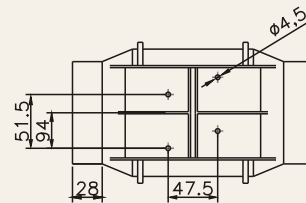

	ØA
TURBO Ø100	98
TURBO Ø125	119

## TECHNICAL DATA

Model	Air flow [m <sup>3</sup> /h]	Static pressure [Pa]	Static pressure [mmH <sub>2</sub> O]	Acoustic pressure [dB(A) 1 m]	Power supply voltage [V/Hz]	Motor speed [rpm]	Power [W]	Power consumption [A]	Max. working temperature [°C]	Weight [kg]	Motor protection rated [IP]	Insulation class
TURBO Ø100	HS	160	72	7,34	230/50	2500	43	0,20	40	1,50	X2	□
	LS	140	60	6,12		2100	28	0,13				□
TURBO Ø125	HS	210	71	7,24	230/50	2500	47	0,22	40	1,50	X2	□
	LS	170	60	6,12		2100	30	0,14				□

HS-high speed  
LS -low speed

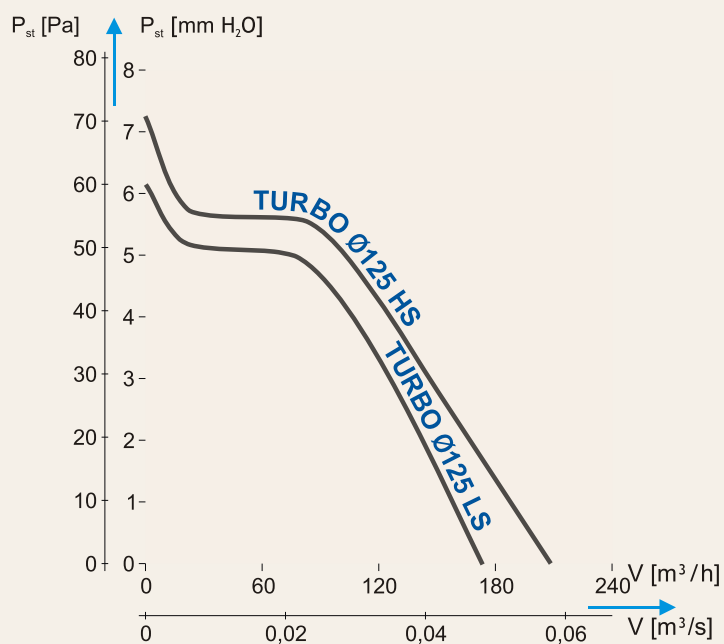
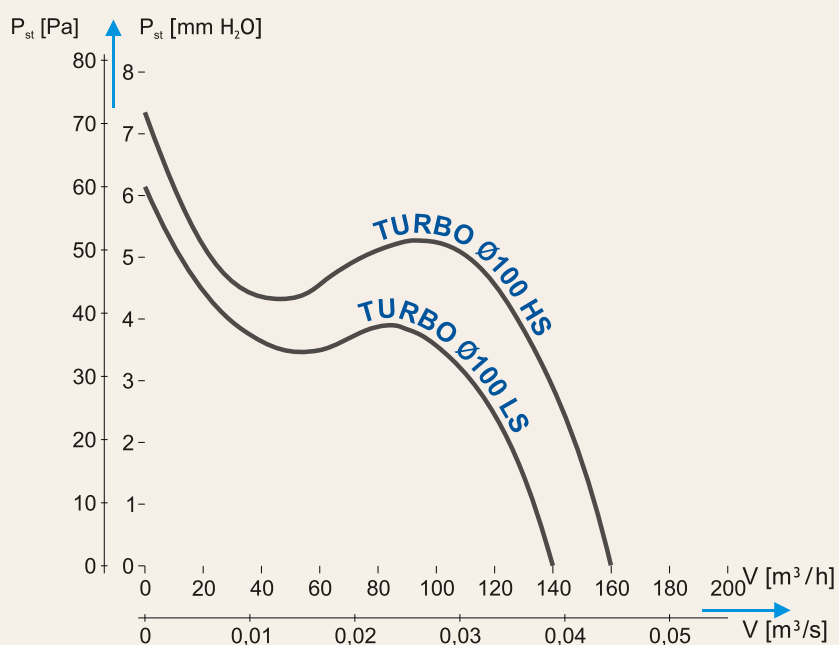

Model	EAN	Item number	Colour	Bulk packaging
TURBO Ø100	590 2289 00171	007 - 0405	white	10 pcs.
TURBO Ø125	590 2289 00172	007 - 0406	white	10 pcs.