

reventon
INDUSTRIAL SOLUTIONS

Technical datasheet

ROOF FAN STORM SERIES



- 1. INTRODUCTION
 - 1.1 GENERAL INFORMATION
 - 1.2 STORAGE AND TRANSPORT
 - 1.3 PACKAGE CONTENT
 - 1.4 APPLICATION
- 2. DEVICE CHARACTERISTIC
 - 2.1 CONSTRUCTION AND PRINCIPLE OF OPERATION
 - 2.2 DIMENSIONS
 - 2.3 TECHNICAL DATA
 - 2.4 WORKING CHARACTERISTICS
- 3. ASSEMBLY
 - 3.1 GENERAL PRINCIPLES
- 4. INSTALLATION
 - 4.1 CONNECTION TO ELECTRICAL INSTALLATION
- 5. EXPLOITATION
 - 5.1 EXPLOITATION PRINCIPLES
- 6. CONTROLS
- 7. WIRING DIAGRAMS
- 8. WARRANTY TERMS

1. INTRODUCTION

Thank you very much for purchasing the roof fan STORM series. Please read and keep this manual for future reference of users and operators.

1.1 GENERAL INFORMATION

The owner and the user of unit Reventon brand should read carefully this documentation and follow included guidelines. In case of any doubts regarding the content, please reach out directly to the manufacturer i. e. the company Reventon Group Sp. z o. o. [Ltd.]. The contact data are given at the section 8 (subsection XVII).

 The key recommendations from safety point of view are marked with the warning triangle (like the one on the left). It enables quick and easy localization of these recommendations and remind of them before interference with the unit. For the same reason, the requirements for periodic inspection and maintenance of the device, are marked with the wrench symbol (like the one on the left).

 During installation, usage or maintenance of the unit, all local safety requirements must be respected.

The owner and each user of unit must be familiar with the Warranty Terms included in the section 8 of this instruction and follow its guidelines. In case of any doubts regarding warranty points, please reach out immediately to the company Reventon Group Sp. z o. o. [Ltd.] before taking any action.

The product was made in EU.

This documentation was developed by the company Reventon Group Sp. z o. o. [Ltd.] - all rights reserved.

The company Reventon Group Sp. z o. o. [Ltd.] reserves the rights to make changes in the technical documentation without previous notice of the user.

1.2 STORAGE AND TRANSPORT

The fan must be stored and transported on an appropriate pallet, in ambient temperature ranging from -30°C to 60°C and relative humidity ≤ 95%.

During collection of the unit, please check the device exactly to exclude any transport damages. If any is observed, the damage report in presence of the product deliverer must be filled. Such report is the basement for the warranty claim. The damage report must be provided by the product deliverer.

 Due to its weight, the device should be handled by two people.

1.3 PACKAGE CONTENT

- roof fan STORM
- technical documentation including Warranty Card

1.4 APPLICATION

The roof fan STORM series is design for external usage, on roofs buildings like production and storage halls, logistic centers or workshops. The device cannot be however used in contaminated environments with air containing flammable or explosive substances, chemicals, sticky substances, fibrous materials or soot and oil particles. The roof fan cannot be also used in places, where it would be exposed to too high humid (relative humidity higher than 90%) or direct contact with water or dust, exceeding the permissible contact due to the protection degree IP.

2. DEVICE CHARACTERISTIC

2.1 CONSTRUCTION AND PRINCIPLE OF OPERATION

Roof: made of powder coated steel. It protects the fan against negative influence of atmospheric conditions.

Roof fan base: made of galvanised steel. It enables easy installation of the device to the roof base. It has also a flange which protects an interior of a building against the water, which otherwise could get into a room with the outlet in the base.

Grid: made of galvanised wire. It is a structural element of the fan - the exhaust fan and the protecting roof are fixed to it. Additionally, it protects rotor against access by unauthorized persons, animals, leaves and other rubbish.

Centrifugal AC fan (for STORM AC devices): made of plastic (STORM 190 AC), galvanized steel (STORM 250 AC) or aluminium (STORM 315 AC, STORM 400 AC and STORM 450 AC). The air is sucked in from the axial direction and extracted radially with backward curved rotor blades. The fan is fixed to the grid.

Centrifugal EC fan (for STORM EC devices): made of plastic (STORM 225 EC) or aluminium (STORM 315 EC, STORM 355 EC, STORM 450 EC and STORM 500 EC). The air is sucked in from the axial direction and extracted radially with backward curved rotor blades. The fan is fixed to the grid.

2.2 DIMENSIONS

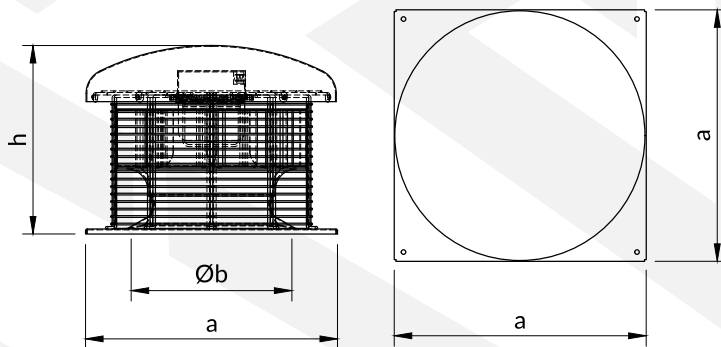

STORM AC MODELS

	STORM 190 AC	STORM 250 AC	STORM 315 AC	STORM 400 AC	STORM 450 AC
a	350±1	350±1	500±1	500±1	700±1
Øb	123±2	165±2	208±2	257±2	370±2
h	190±5	230±5	320±5	330±5	420±10

STORM EC MODELS

	STORM 225 EC	STORM 315 EC	STORM 355 EC	STORM 450 EC	STORM 500 EC
a	350±1	500±1	500±1	700±1	700±1
Øb	144±2	210±2	240±2	412±2	450±2
h	230±5	320±5	360±5	450±5	560±10

2.3 TECHNICAL DATA

STORM AC MODELS

MODEL	STORM 190 AC	STORM 250 AC	STORM 315 AC	STORM 400 AC	STORM 450 AC
Product code	STORM190A C-2017	STORM250A C-1981	STORM315A C-1982	STORM400A C-2018	STORM450A C-2333
Maximal airflow [m³/h]	520	1370	1900	3100	6700
Voltage [V] / Frequency [Hz]	230 / 50	230 / 50	230 / 50	230 / 50	400 / 50
Nominal motor current [A]	0.25	0.68	0.60	1.15	3 x 1.50
Nominal motor power [W]	56.5	150	135	252	800
Nominal motor speed [rpm]	2340	2380	1400	1340	1350
IP protection rating of motor [-]	44	44	44	44	44
Insulation class [-]	F	F	F	F	F
Net weight [kg]	7.0	8.5	11.5	15.0	25
Noise [dB]*	55	54	52	56	70

* the measurement at the distance of 5 m from the device

STORM EC MODELS

MODEL Product code	STORM 225 EC STORM225EC -1983	STORM 315 EC STORM315EC -1984	STORM 355 EC STORM355EC -2019	STORM 450 EC STORM450EC -2334	STORM 500 EC STORM500EC -2335
Maximal airflow [m ³ /h]	950	2250	3600	7300	13800
Voltage [V]/ Frequency [Hz]	230 / 50	230 / 50	230 / 50	400 / 50	400 / 50
Nominal motor current [A]	0.70	1.07	2.80	3 x 1.67	3 x 4.95
Nominal motor power [W]	82	160	345	1006	3000
Nominal motor speed [rpm]	2340	2380	1400	1450	1800
IP protection rating of motor [-]	44	44	44	44	44
Insulation class [-]	F	F	F	F	F
Net weight [kg]	7.0	8.5	11.5	24	32
Noise [dB]*	55	54	52	68	85

* the measurement at the distance of 5 m from the device

2.4 WORKING CHARACTERISTICS

STORM AC MODELS

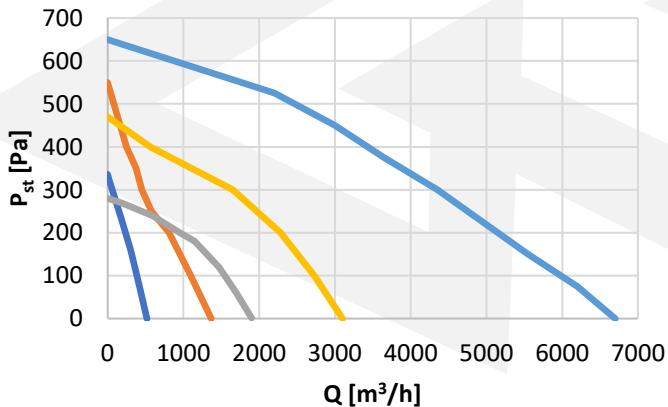

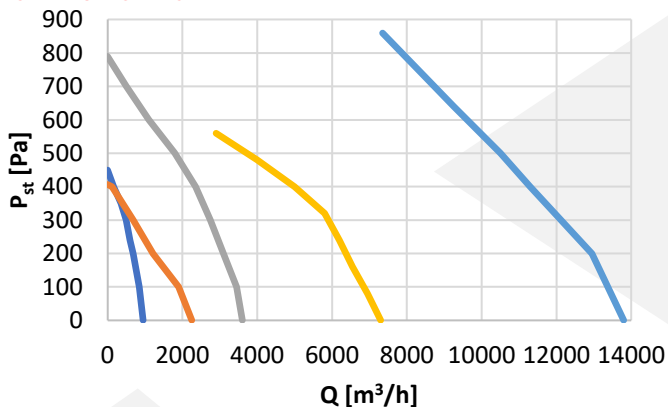

STORM EC MODELS



3 ASSEMBLY

3.1 GENERAL PRINCIPLES

-  The roof fan should be assembled by people experienced in mounting of such devices and - if local law requires it - with appropriate qualifications.
-  Due to the relatively large weight and the dimensions of the roof fan, the assembly should be performed by at least two people and at least one of them must meet the requirements in the paragraph above.
-  It is the responsibility of the assemblers to make the mounting according to the guidelines from this instruction and in accordance with the local regulations in force.

After mounting of the device, the assembler is obliged to fill out the Warranty Card (positions 1 and 2). It is also treated as a guarantee, that the assembly was made in accordance with the requirements. The Warranty Card is included in this manual under the Warranty Terms.

The roof fan should not be installed directly on a roof - it is designed for mounting on a roof base. There are four holes in the roof fan base for screws M6, enabling screwing unit to the roof base. Constructions dedicated for roof fan STORM series can be found in Reventon Group offer.

 Before mounting the roof base and the roof fan itself, it must be verified, if the building partition on which the elements will be installed has a load capacity appropriate to its weight. The weight of the roof fan with the roof base may exceed 60 kg.

 The roof fan must be mounted using elements with a load capacity appropriate to its weight.

 Mounting elements used for the assembly of unit, must be allowed for outdoor use.

The roof fan can be an element of decentralised ventilation systems or a part of a ventilation system with piping. In the latter case please be aware that the actual airflow of the device would be lower than the maximal one, due to flow resistance in the pipes / ducts (according to the working characteristics in point 2.4).

4. INSTALLATION

 Before connecting the unit to an electrical installation, it must be assembled permanently to a suitable partition (according to the recommendations contained in the section 3).

 All installation, repairs and disassembly works, must be performed by qualified persons i. e. having the appropriate qualifications for these works. It is the responsibility of the installer to make the installation according to the guidelines from this instruction and in accordance with the local regulations in force.

After connecting to the heating or electric installations, the installer is obliged to make an entry in the Warranty Card, confirmed by a stamp and signature (positions 3 and 4). It is also treated as a guarantee, that the installation was made in accordance with the requirements of this point 4. The Warranty Card is included in this manual under the Warranty Terms in the section 8.

4.1 CONNECTION TO ELECTRICAL INSTALLATION

 The electrical installation must be carried out in accordance with the state of the art and the local regulations in force.

 The electrical connection to an installation with the electrical parameters according to the section 2.3 should be made in according to the appropriate connection diagram (see section 7).

 As the power cable, it is recommended to use a three-core cable with a 1.5 mm² cross-section with earthing.

 The electrical circuit to which the device is connected, should include all safety element required by the law and the ON/OFF switch enabling safe disconnection of the roof fan from the electrical system. These elements are indicated overall as no 2 on the connection diagrams in the section 7.

 Before the start up, it is required to check the electrical installation in terms of damaged insulation, incorrect connection in the terminals, risk of potential short circuits etc.

5. EXPLOITATION

5.1 EXPLOITATION PRINCIPLES

 The user is obliged to be familiar with this instruction before exploitation of the device.

 Before any interference in the device, the electricity supply to the roof fan must be absolutely cut off.

 Access to the device by parties like unauthorised people, children and animals is forbidden and should be prevented or at least hindered.

 The device cannot work with covered or restricted air inlet or outlet (e. g. as a result of not keeping the minimum distances from partitions or obstructed inlet/outlet).

 The unit is designed for handling of air at temperature ranging from -25°C to 60°C and with relative humidity ≤ 90%.

 In case of any malfunctions (like blow a fuse, unusual noise etc.), immediately cut off the device from the electrical system and contact directly with the installer, the manufacturer or the distributor. It is forbidden to turn on the unit before diagnosing and removing the reason of this malfunction.

 If the device is not used for a longer time, disconnect the unit from the electrical installation.

 Periodical inspection and maintenance of the device according to the guidelines below, should be carried out at least once a year and always after two-weeks or a longer period of inactivity.

 Before starting any maintenance work, the roof fan must be disconnected from the power supply.

 At the periodic inspection and maintenance, the following should be successively done:

- check the condition of the wiring for its damage and remove/repair any damage
- verify air inlet and outlet, slots in external wall and rotor itself -> if there are any restriction or contamination, remove them
- clean the fan and its housing from residue with a soft cloth
- connect the device to the power supply and assess if the fan works correctly at each stage; additional murmur, metallic reverberation, grinding noise, vibration etc. says about a malfunction - in such case, immediately cut off the device from the electrical system and contact directly with the installer, the manufacturer or the distributor

 Inspection and maintenance of the roof fan should be carried out by a user who is familiar with this instruction or by an external entity if due to the way of assembly or local regulations additional authorisations like e. g. working with electricity or at heights are required.

 The frequency of the service should depend on the actual dirtiness - if the device is operating in an environment with a high concentration of dust, periodic cleaning should be performed much more often.

After exploitation time, please utilise the unit according to the local regulations.

6. CONTROLS

Using of control dedicated to STORM gives vast possibilities of adjusting the efficiency of the unit in different degree of automation, depending on the needs.

CONTROLLING FOR STORM WITH AC 230 V MOTORS

PROGRAMMABLE CONTROLLER HMI SINGLE

The controller is used to regulate devices equipped with 1-stage fans. It is an advanced controller with many functions i. a. operation in heating, cooling or mixed mode, programmable mode, valve control, automatic selection of the fan speed. Together with the controller the external sensor is provided, which allows to read the temperature in the required place, even remote from the controller. In addition, the device can operate in one of two modes - thermostatic or temperature difference. The second one enables effective controlling of de-stratification fans. The controller can be integrated with the BMS building control system (using the MODBUS communication protocol).



Voltage / Frequency: 230 V AC / 50 - 60 Hz
Maximum current load: 5 A
Operating temperature range: 0 - 45°C
Regulation range: 5°C - 35°C
Regulation accuracy: 0.5°C
External temperature sensor: NTC 10K
Communication (BMS): RS485
Dimensions: 86 x 86 x 13,3 mm
Weight: 0.27 kg
Degree of protection (housing): IP 20
Degree of protection (external sensor): IP 68

FAN SPEED CONTROLLER HC

The controller is designed to change the single-phase fan's speed by changing the supply voltage. The item has the 5-level knob which enables to change the supply voltage - level 1 represents the lowest voltage while level 5 represents the nominal voltage (i. e. 230 V). The levels 2-4 represents the intermediate vales of voltages. The selection of the appropriate model depends on the number of the devices that will be connected to the to one regulator - the total intensity of the connected devices cannot exceed the maximum current flow of the regulator.



Voltage / Frequency: 230 V AC / 50 - 60 Hz
Maximum current load (depending on model):
1,2 A, 3 A, 5 A, 7 A or 14 A
Protection: thermal switch
Weight (depending on model):
1.45 kg, 2.5 kg, 4.5 kg, 5.5 kg or 10.5 kg
Degree of protection (housing): IP 54

THYRISTOR SPEED CONTROLLER TRO

The controller enables reduction of rotational speed by lowering the supply voltage for a single phase motor by the phase cutting method. It is available in two variants - for motors with a power below 150 W, TRO 150W is recommended, for those with a power between 150 - 600 W, TRO 600W is recommended.



Voltage/Frequency: 220 ~ 240 V / 50 ~ 60 Hz
Maximum load:
150 W for TRO-150W
600 W for TRO-600W
Operating range: $t = -20 - 55^{\circ}\text{C}$, $20\% < \varphi < 90\%$
Housing material: ABS (fireproof)
Dimensions (TRO-150W): 86 x 86 x 42 mm
Dimensions (TRO-600W): 86 x 86 x 40 mm

RELAY MODULE RM-16A

The relay enables to control of electricity devices (e. g. fans) which consume higher current that the permissible one for a connected regulator.



Voltage / Frequency: 230 V AC / 50 - 60 Hz
Maximum current load: 16 A
Inputs: dry contact NO/COM and SL voltage
Output: relay NO/COM/NC
Dimensions: 47 x 47 x 20 mm

CONTROLLING FOR STORM WITH EC MOTORS

PROGRAMMABLE CONTROLLER HMI EC

The controller is used to regulate equipped with EC motors. It is an advanced controller with many functions i. a. operation in heating, cooling or mixed mode, programmable mode, valve control, automatic selection of the fan speed. Together with the controller an external sensor is provided. The controller can be integrated with the BMS building control system (using the MODBUS communication protocol).



Voltage / Frequency: 230 V AC / 50 - 60 Hz
Maximum current load: 5 A
Operating temperature range: 0 - 45°C
Regulation range: 5°C - 35°C
Regulation accuracy: 0.5°C
External temperature sensor: NTC 10K
Communication (BMS): RS485
Dimensions: 86 x 86 x 13,3 mm
Weight: 0.27 kg
Degree of protection (housing): IP 20
Degree of protection (external sensor): IP 68

POTENTIOMETER EC

Potentiometer enables to control EC motors by 0-10 V control signal. A convenient knob is used for this, allowing to adjust the fan efficiency in the range of 0-100%.



Output signal: 0 - 10V
Voltage: 10V DC
Operating temperature range: -15°C - 55°C
Dimensions: 86 x 86 x 37 mm
Weight: 0.11 kg
Degree of protection (housing): IP 20

7. WIRING DIAGRAM

STORM 190 AC, STORM 250 AC, STORM 315 AC and STORM 400 AC

LEGEND

- 1 – voltage supply 230 V/50 Hz
- 2 – protections of the electrical circuit and ON/OFF switch
- 3 – roof fan STORM 190 AC, 250 AC, 315 AC or 400 AC
- 4 – programmable controller HMI SINGLE
- 5 – external temperature sensor

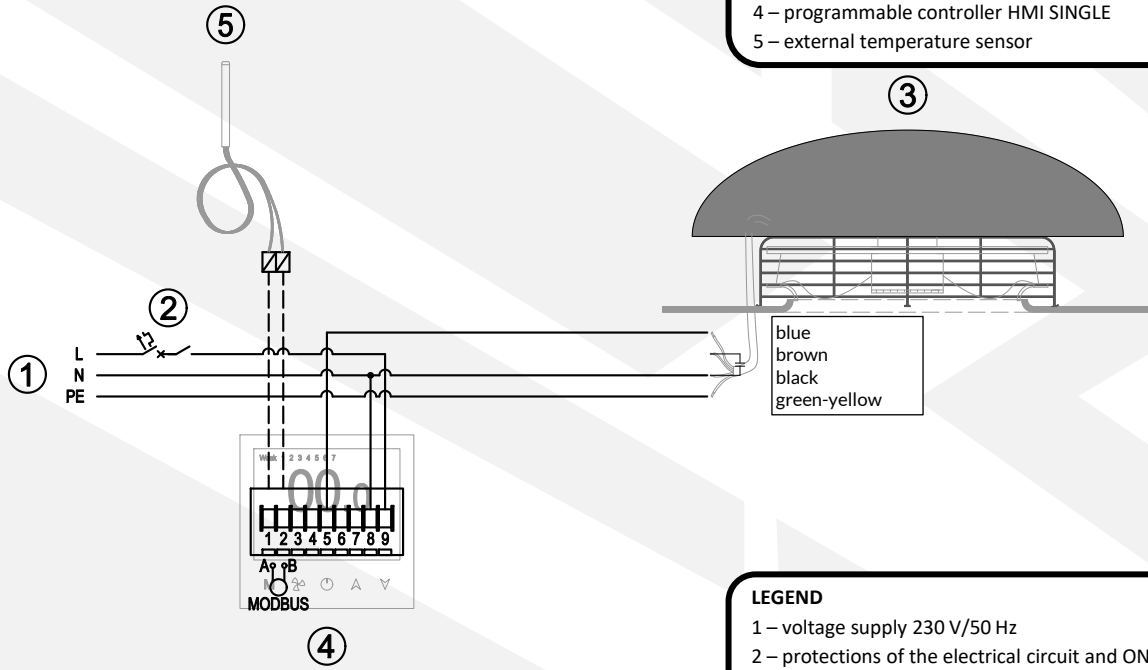

LEGEND

- 1 – voltage supply 230 V/50 Hz
- 2 – protections of the electrical circuit and ON/OFF switch
- 3 – roof fan STORM 190 AC, 250 AC, 315 AC or 400 AC
- 6 – fan speed controller HC

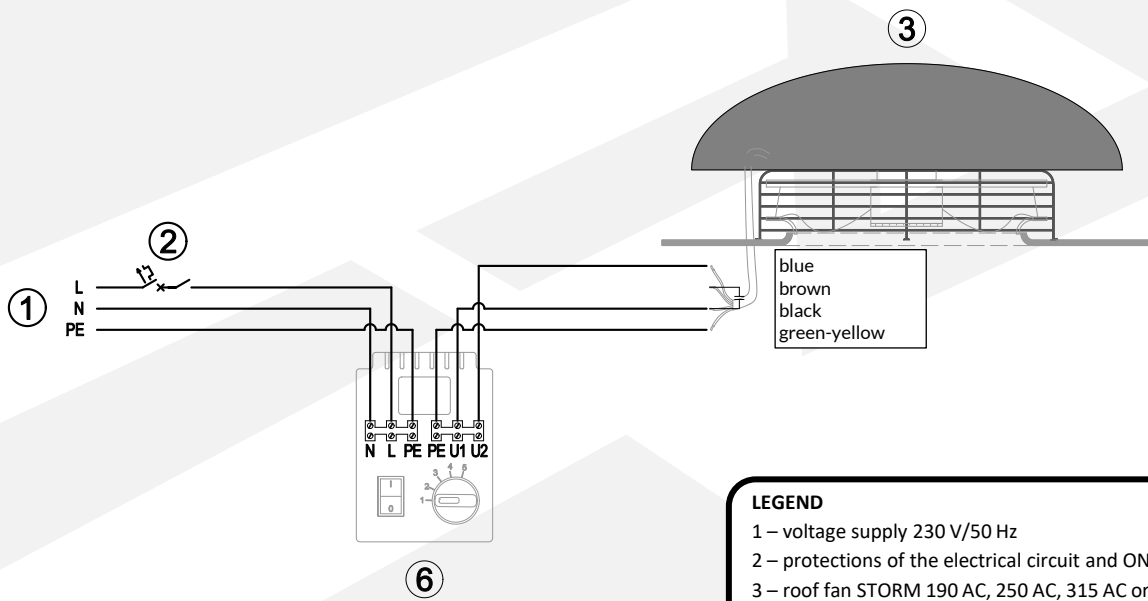

LEGEND

- 1 – voltage supply 230 V/50 Hz
- 2 – protections of the electrical circuit and ON/OFF switch
- 3 – roof fan STORM 190 AC, 250 AC, 315 AC or 400 AC
- 7 -thyristor speed controller TRO

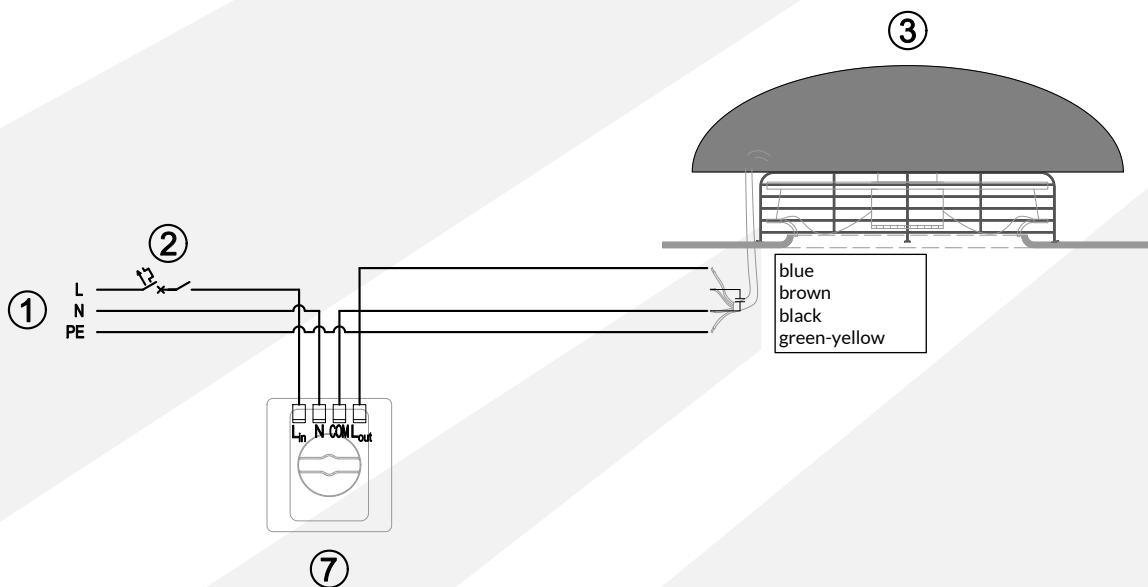

STORM 450 AC

LEGEND

- 1 – voltage supply 400 V/50 Hz
- 2 – protections of the electrical circuit and ON/OFF switch
- 8 – roof fan STORM 450 AC

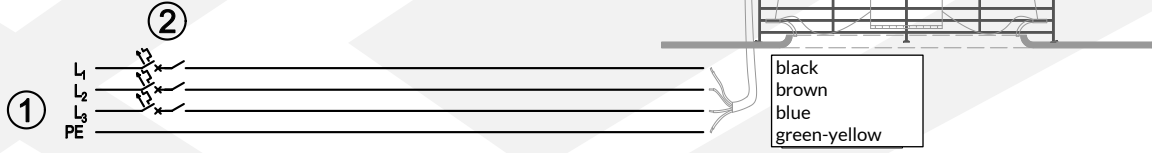

STORM 225 EC, 315 EC and 355 EC

LEGEND

- 1 – voltage supply 230 V/50 Hz
- 2 – protections of the electrical circuit and ON/OFF switch
- 9 – roof fan STORM 225 EC, 315 EC or 355 EC
- 10 – potentiometer EC

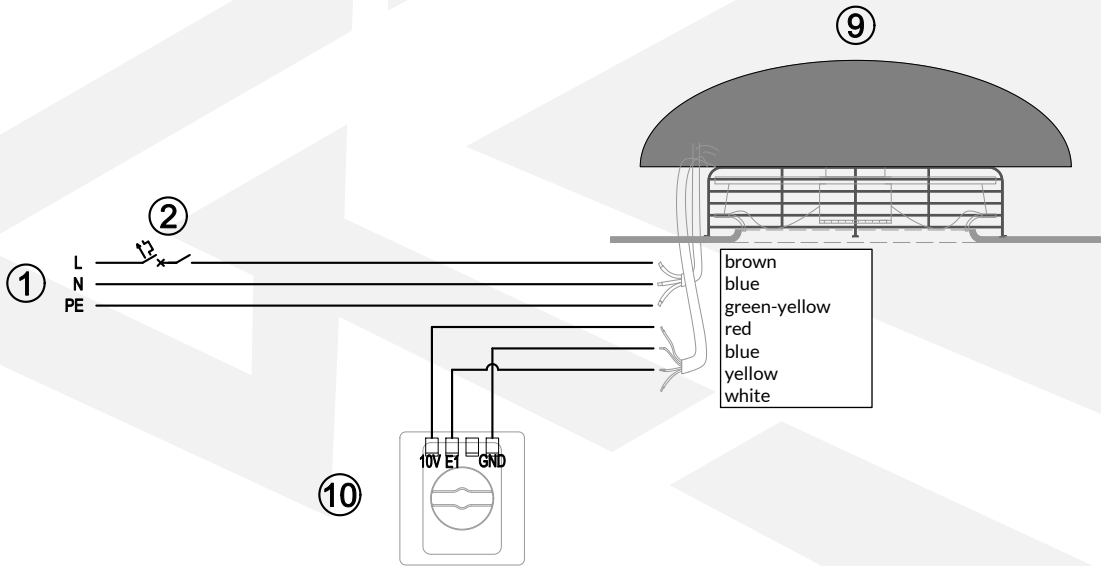

STORM 450 EC and 500 EC

LEGEND

- 1 – voltage supply 400 V/50 Hz
- 2 – protections of the electrical circuit and ON/OFF switch
- 10 – potentiometer EC
- 11 – roof fan STORM 450 EC or 500 EC

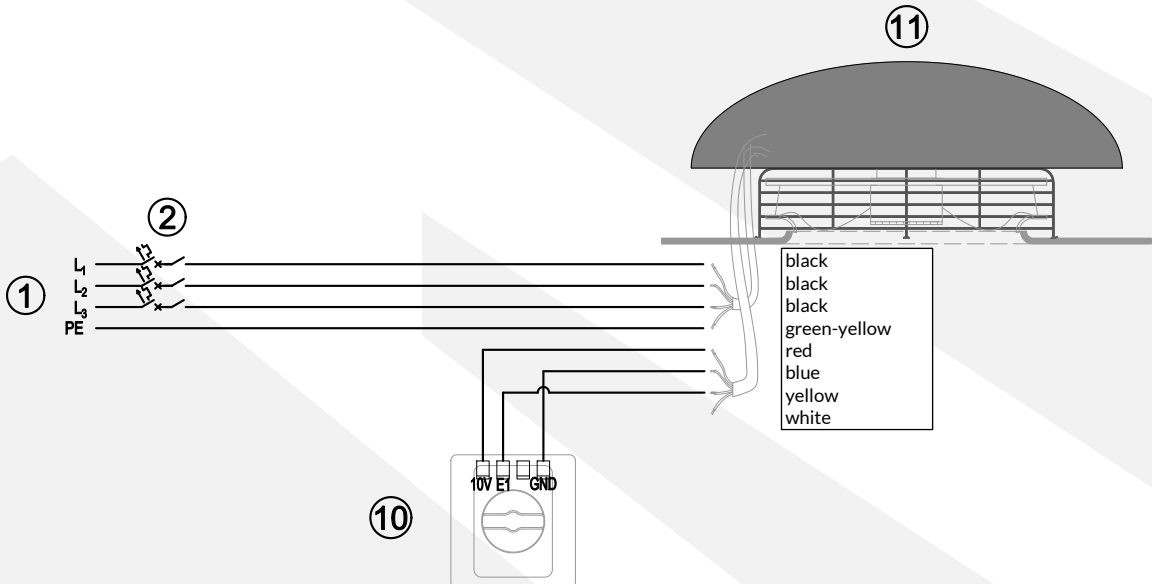

8. WARRANTY TERMS

I. The company Reventon Group Sp. z o. o. [Ltd.], hereinafter referred to as the guarantor, provides 24-month warranty protection period for the following devices:

- roof fan STORM 190 AC
- roof fan STORM 250 AC
- roof fan STORM 315 AC
- roof fan STORM 400 AC
- roof fan STORM 450 AC
- roof fan STORM 225 EC
- roof fan STORM 315 EC
- roof fan STORM 355 EC
- roof fan STORM 450 EC
- roof fan STORM 500 EC

II. The warranty protection is valid from the purchasing date by end user (i.e. the issue date of invoice) but not longer than 30 months from leaving the warehouse of Reventon Group Sp. z o. o. [Ltd.].

III. The warranty claim should be reported via the complaint form on the website (<https://reventongroup.eu/en/complaints>). The scan or the photo of the fulfilled Warranty Card and the purchase invoice must be attached to the form. The Warranty Card is not required in case of accessories.

IV. The guarantor is committed to consider the claim within 14 working days since the date of reporting (i. e. the day of receipt of the correctly fulfilled warranty form).

V. In exceptional cases, the guarantor reserves the right to extend the time for consideration of the request, especially if the defect is not permanent one and its determination requires a deeper analysis. The extension must be notified by the guarantor before the end of the 14th working day.

VI. Under the warranty, the guarantor provides a repairment, replacement (the device or its component) or refund for the defective item within a specified time.

VII. In the case of replacement of a device component, the warranty protection of the whole unit is not prolonged.

VIII. The guarantor does not cover the costs of disassembly and eventual reassembly of the complaint device.

IX. The guarantor may decide to bring the defective device or its component to the service of Reventon Group Sp. z o. o. [Ltd.]. In such case the transport of the item is organised and paid by the guarantor. The responsibility of the device's owner is to prepare the item for the shipment - the device must be packed in a way which protects it against transport damages and the dimensions and weight of the package must not exceed 660 x 650 x 400 mm and 30 kg respectively. In the case of elements which cannot be packed in this way, the method of shipment must be agreed and approved by Reventon Group Sp. z o. o. [Ltd.]. In the case of sending a non-standard package without agreement of the service of Reventon Group Sp. z o. o. [Ltd.], the guarantor reserves the right to charge the owner of device with all additional transport costs.

X. In the case of arrival of the authorized service of the guarantor or an installer to fix the complaint item, the customer must ensure them seamless access to the device and all required media like electricity, water, lighting etc. free of charge.

XI. The warranty protection does not cover the parts of the device subject to the normal usage and the following cases:

a) mechanical damage of the product

b) defects and damages through:

- improper storage or transport

- improper or non-compliant use and maintenance (i. e. inconsistent with the manual)

- using the device in the improper conditions (too high humidity, too high or too low temperature, impact of the surrounding, sun etc.)

- unauthorized (i. e. by the user or other unauthorized persons) repairs, modifications or construction changes

- connecting equipment inconsistent with the technical documentation

- connecting additional equipment, which is not recommended by the guarantor

- improper power supply

- random events (like fire, flood, storm etc.)

c) elements which wear and tear such as discolour of the housing

If there is any of the above, the claimant will be charged for transport and /or repairs.

XII. During collection of the device, the item must be checked exactly by the receiver to exclude transport damages. If any of them is observed, the damage report in presence of the product deliverer have to be filled - such report is the basement for the warranty claim. The damage report must be provided by the product deliverer.

XIII. The guarantor does not take the responsibility for potential losses and damages related to the downtime of the device during its failure and the complaint considering time.

XIV. Any changes in the Warranty Terms, improper use of the product as well as traces of self repairing (beyond the guarantor service) or alterations cause, the warranty become invalid.

XV. These Warranty Terms do not exclude or limit any rights arising from the pledge.

XVI. Not following to any of the warranty regulations makes the protection invalid.

XVII. All correspondence should be sent to the following address: Reventon Group Sp. z o.o. [Ltd.], 556 Wyzwolenia Street, 43 340 Kozy, Poland or email address: serwis@reventongroup.eu.

Warranty Card

1 - Model and serial number* or product code	2 - Address and place of assembly
3 - Date of connection to:	4 - Stamp and signature of installer:
Heating/cooling installation (if applicable)	
Ventilation installation (if applicable)	
Electrical installation (if applicable)	

* serial number is required only for water heaters HC-3S, HC-EC and FARMER HCF series and recovery units INSPIRO, INSPIRO BASIC and VERTIC series

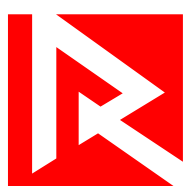

reventon
INDUSTRIAL SOLUTIONS

Reventon Group Sp. z o.o. [Ltd.], 556 Wyzwolenia Street, 43-340 Kozy, Poland, www.reventongroup.eu